

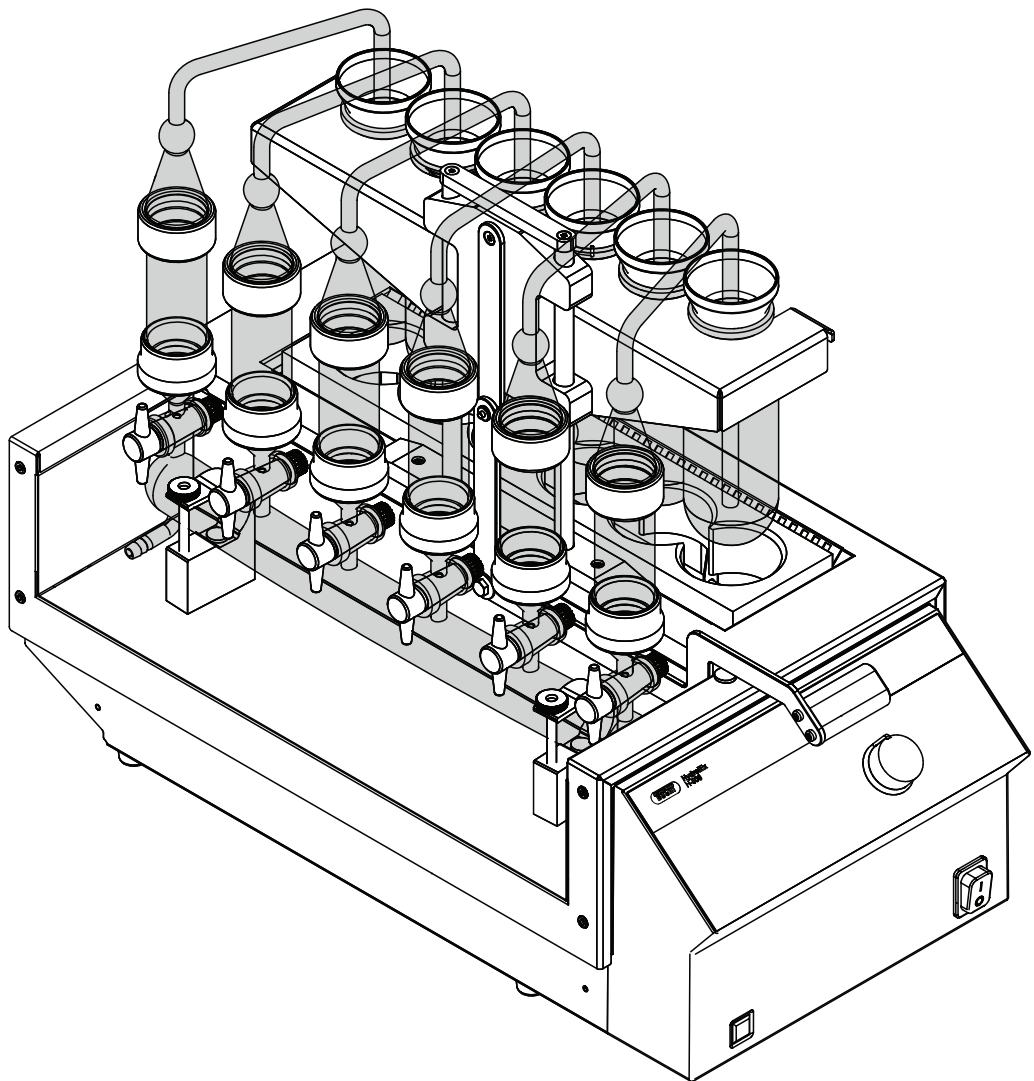

# HydroEx H-506

## Technical data sheet

The HydroEx H-506 ensures convenient and safe acid hydrolysis for total fat content determination handling six samples simultaneously. The method complies with the standardized methods (Weibull Stoldt, AOAC).



## Order Code

Choose the configuration according to your needs:

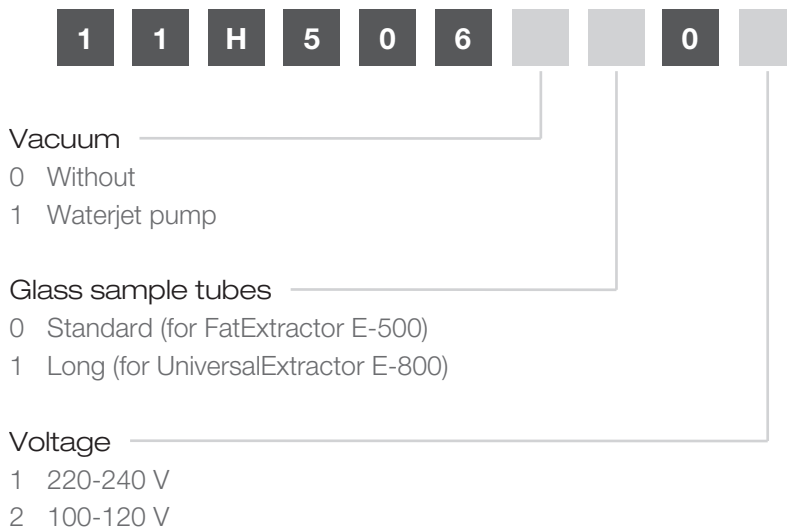

## Scope of delivery

All configurations are supplied ready to use.

	HydrolEx H-506 for FatExtractor E-500	HydrolEx H-506 for UniversalExtractor E-800
HydrolEx H-506	1	1
Upper rubber couplings	6	6
Lower rubber couplings bottom	6	6
Glass sample tube with frit	6	-
Glass sample tube with frit, long	-	6
Rinsing funnel	6	6
Sample aspiration tube	6	-
Sample aspiration tube, long	-	6
Suction tube cpl.	1	1
Hydrolysis vessel	6	6
Vacuum hose 2 m	1	1
Quartz sand 2.5 kg	1	1
Power cable	1	1
Operation Manual	1	1

## HydroEx H-506

Specification	HydroEx H-506 for 115 V	HydroEx H-506 for 230 V
Dimensions (W x D x H)	312 x 614 x 470	312 x 614 x 470
Weight (without glassware)	13 kg	13 kg
Weight (with glassware)	16.5 kg	16.5 kg
Connection voltage	110 - 120 ± 10 % VAC	220 - 240 ± 10 % VAC
Fuse	10 A	10 A
Frequency	50 / 60 Hz	50 / 60 Hz
Overvoltage category	II	II
Protection class	1	1
Pollution degree	2	2
Power consumption	1200 W	1200 W
Temperature range heater	70 - 495 °C	70 - 495 °C
Total Heating power	1200 W	1200 W
Number of hydrolysis positions	6	6
Approvals	CE / CSA	CE / CSA

### Ambient conditions

For indoor use only.

Max. altitude above sea level	2000 m
Ambient temperature	5–40 °C
Maximum relative humidity	80% for temperatures up to 31 °C decreasing linearly to 50 % relative humidity at 40 °C
Storage temperature	max. 45 °C

## Spare parts

	Order no.	Image
Insulation plate	11065169	
Suction tube, cpl.	11064546	
Set of hydrolysis vessels, 2 pcs.	11064547	
Set of aspiration tubes, 2 pcs.	11064548	
Set of aspiration tubes, long, 2 pcs.	11069475	
Glass sample tubes with frit, 6 pcs.	11067497	
Glass sample tubes with frit, long, 6 pcs. The glass sample tubes with 150 mm length fit perfectly into the Universal glass extraction chamber.	11067815	
Set of rinsing funnels, 2pcs.	11067582	
Vacuum hose, 2 m	040459	

	Order no.	Image
Set of upper couplings, FKM, 3 pcs.	11068611	
Set of lower couplings, FKM, 3 pcs.	11068612	

## Accessories

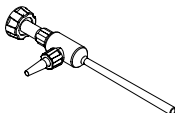
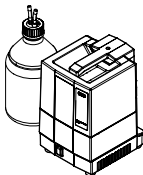
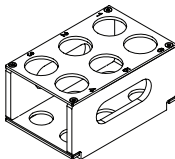
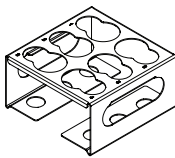
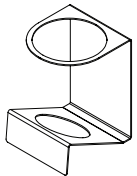
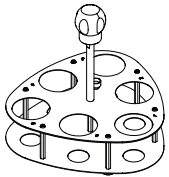
	Order no.	Image
Water jet pump. Plastic Used when tap water is used to generate vacuum.	002913	
Suction set with pump Vacuum pump V-100, bottle, tubing	11068473	
Holder for glass sample tubes, PTFE	11067220	
Holder for glass sample tubes, stainless steel	11067219	
Weighing support for hydrolysis vessels	11067040	
Hydrolysis vessel carrier	11067492	

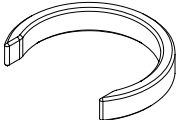
	Order no.	Image
<p>Adapter clips for B-411 sample tubes, 4 pcs.</p> <p>These adapters allow the use of glass sample tubes for B-411/ B-811 on combination with the HydrolEx H-506. In addition the rubber couplings of the E-416 / B-411 are needed for the use in the H-506. EPDM (037381) or Viton (044491)</p>	11069239	

## Consumables

	Order no.
Quartz sand 0.3 - 0.9 mm, 2.5 kg	037689
Celite® 545, 1 kg	11068920
Quartz sand (25 kg)	034925