

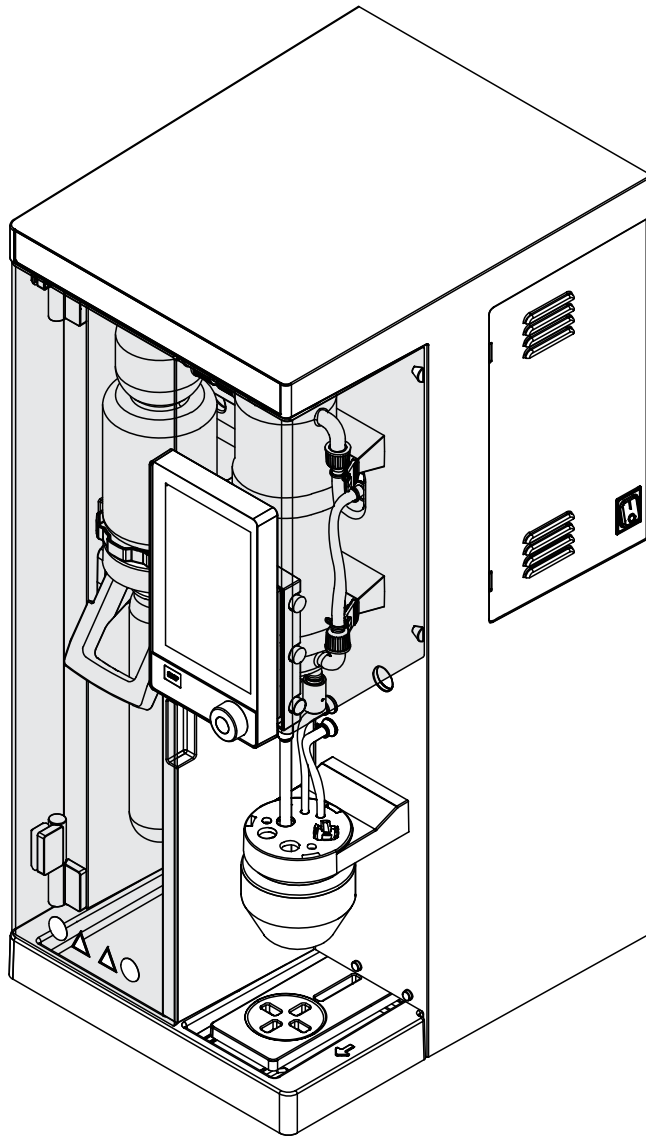

# K-365 Kjel Line

Operation Manual



## **Imprint**

Product Identification:

Operation Manual (Original) K-365 Kjeh Line  
11594238

Publication date: 07.2021

Version A

BÜCHI Labortechnik AG

Meierseggrasse 40

Postfach

CH-9230 Flawil 1

E-Mail: [quality@buchi.com](mailto:quality@buchi.com)

BUCHI reserves the right to make changes to the manual as deemed necessary in the light of experience, especially with respect to structure, illustrations and technical details.

This manual is copyrighted. Information from it may neither be reproduced, distributed, or used for competitive purposes, nor made available to third parties. The manufacture of any component with the aid of this manual without prior written agreement is also prohibited.

## Table of contents

<b>1</b>	<b>About this document.....</b>	<b>9</b>
1.1	Mark-ups and symbols .....	9
1.2	Trademarks .....	9
1.3	Connected devices .....	9
<b>2</b>	<b>Safety .....</b>	<b>10</b>
2.1	Proper use .....	10
2.2	Use other than that intended .....	10
2.3	Staff qualification .....	10
2.4	Personal protective equipment .....	11
2.5	Warning notices in this document.....	11
2.6	Warning and directive symbols.....	11
2.7	Protection devices .....	12
2.8	Residual risks .....	12
	2.8.1 Hot surfaces .....	13
	2.8.2 Faults during operation.....	13
	2.8.3 Glass breakage .....	13
	2.8.4 Not suitable titrators.....	13
	2.8.5 Dosing pump defect.....	13
2.9	Modifications.....	13
<b>3</b>	<b>Product description.....</b>	<b>14</b>
3.1	Description of function .....	14
3.2	Configuration .....	14
	3.2.1 Front view .....	14
	3.2.2 Rear view.....	16
	3.2.3 Receiving area.....	16
	3.2.4 Communication connections .....	18
	3.2.5 Connections on the rear side.....	20
3.3	Scope of delivery .....	24
3.4	Type plate.....	24
3.5	Technical data .....	24
	3.5.1 K-365 Kjeh Line .....	24
	3.5.2 Ambient conditions .....	26
	3.5.3 Materials .....	26
	3.5.4 Installation site.....	27
<b>4</b>	<b>Transport and storage .....</b>	<b>28</b>
4.1	Transport .....	28
4.2	Storage .....	28
4.3	Lifting the instrument .....	28

<b>5</b>	<b>Installation</b> .....	<b>29</b>
5.1	Before installation .....	29
5.2	Establishing electrical connections .....	29
5.3	Securing against earthquakes .....	29
5.4	Installing the cooling water supply .....	30
5.4.1	Installing a tap water supply (option) .....	30
5.4.2	Installing the recirculating chiller on the condenser (option).....	30
5.5	Installing the drain tubing (option) .....	31
5.6	Installing the waste pump connection (BasicKjel, MultiKjel, MultiKjel T only) .....	31
5.7	Installing the sample waste pump connection (MultiKjel T only) .....	32
5.8	Installing the H <sub>2</sub> O supply for steam generation .....	32
5.9	Installing NaOH supply (MultiKjel, MultiKjel T only).....	33
5.10	Installing H <sub>3</sub> BO <sub>3</sub> supply (MultiKjel, MultiKjel T only) .....	33
5.11	Installing the H <sub>2</sub> O supply for the sample tube (MultiKjel, MultiKjel T only) .....	34
5.12	Installing the level sensor on the canister (option) .....	35
5.13	Installing a titrator with LAN (MultiKjel T with Eco Titrator only) .....	35
5.14	Installing a titrator with RS232 (MultiKjel only) .....	36
5.15	Installing a dispenser (MultiKjel T only) .....	37
5.16	Installing the reaction detection sensor (MultiKjel T only) .....	37
5.17	Installing a SD card (Interface pro only) .....	37
5.18	Installing the level detection sensor (option) .....	37
5.19	Installing the stirrer (MultiKjel only).....	38
<b>6</b>	<b>Description of the interface</b> .....	<b>39</b>
6.1	Layout of the interface .....	39
6.2	Function bar interface .....	40
6.3	Menu bar interface.....	40
6.3.1	Home menu .....	41
6.3.2	Manual control menu .....	41
6.3.3	Method menu.....	41
6.3.4	Configuration menu .....	41
6.3.5	Determination data menu .....	43
6.4	Status bar interface .....	43
<b>7</b>	<b>Description of the interface pro</b> .....	<b>45</b>
7.1	Layout of the interface pro.....	45
7.2	Function bar interface pro.....	46
7.3	Menu bar interface pro .....	47
7.3.1	Home menu .....	47
7.3.2	Manual control menu .....	47
7.3.3	Method menu.....	48
7.3.4	Configuration menu .....	48
7.3.5	Determination data menu .....	50
7.4	Status bar interface pro .....	50

<b>8</b>	<b>Preparations for a determination .....</b>	<b>52</b>
8.1	Editing the preheating function .....	52
8.2	Editing the priming function .....	52
8.3	Editing the single determination .....	52
8.3.1	Changing the name of the single determination .....	52
8.3.2	Selecting the determination type for a single determination .....	53
8.3.3	Selecting the method for a single determination .....	53
8.3.4	Changing the sample quantity for single determination.....	54
8.3.5	Changing the unit for a single determination .....	54
8.4	Editing a series .....	55
8.4.1	Creating a new series .....	55
8.4.2	Changing the name of a series.....	55
8.4.3	Adding a determination to a series .....	56
8.4.4	Deleting a determination from a series.....	56
8.4.5	Changing the determination name for a series.....	56
8.4.6	Selecting the determination type within a series .....	57
8.4.7	Selecting the method for a determination within a series .....	58
8.4.8	Changing the sample quantity for determination within a series .....	58
8.4.9	Changing the amount unit for a determination within a series.....	58
8.5	Editing a template .....	59
8.5.1	Creating a new template.....	59
8.5.2	Changing the name of a template .....	60
8.6	Editing a method.....	60
8.6.1	Creating a new method .....	60
8.6.2	Deleting a method .....	60
8.6.3	Changing the name of a method .....	61
8.6.4	Changing the reaction detection for a method (option for MultiKjel only) .....	61
8.6.5	Changing the H <sub>2</sub> O volume for a method (MultiKjel only) .....	62
8.6.6	Changing the H <sub>2</sub> SO <sub>4</sub> volume for a method (MultiKjel only).....	62
8.6.7	Changing the NaOH volume for a method (MultiKjel only).....	63
8.6.8	Changing the acid volume for a method (BasicKjel, MultiKjel only) .....	63
8.6.9	Changing the reaction time for a method (BasicKjel, MultiKjel only) .....	64
8.6.10	Changing the number of steam steps for a method .....	64
8.6.11	Changing the time a steam step is carried out for a method .....	65
8.6.12	Changing the steam power for a method .....	66
8.6.13	Changing the level detection sensor settings (option) for a method.....	66
8.6.14	Changing the distillation time for a method .....	67
8.6.15	Changing the distillation stirring speed for a method (MultiKjel T only).....	67
8.6.16	Changing the titration type for a method (MultiKjel T only).....	68
8.6.17	Changing the H <sub>3</sub> BO <sub>3</sub> volume for a method (MultiKjel only).....	68
8.6.18	Changing the dosing unit volume for a method (MultiKjel T only) .....	69
8.6.19	Changing the titration stirring speed for a method (MultiKjel T only).....	69
8.6.20	Changing the titration start time for a method (MultiKjel T only).....	69
8.6.21	Changing the aspiration time for the sample tube for a method (BasicKjel, MultiKjel, MultiKjel T only).....	70
8.6.22	Changing the aspiration time for the receiving vessel for a method (MultiKjel T only) .....	70
8.7	Editing user setting .....	71
8.7.1	Creating a new user .....	71
8.7.2	Deleting a user .....	71
8.7.3	Changing the name of a user .....	72

8.7.4	Selecting a user .....	72
8.8	Installing the sample tube .....	72
8.9	Installing a receiving vessel .....	73
8.10	Preparing the end stop for the sample tube size .....	73
8.11	Preparing the level detection sensor (option) .....	74
8.12	Selecting the operation mode .....	74
8.13	Dosing manually .....	74
8.13.1	Dosing H <sub>2</sub> O manually .....	74
8.13.2	Dosing NaOH manually .....	75
8.13.3	Dosing H <sub>3</sub> BO <sub>3</sub> manually .....	75
8.14	Aspirating manually .....	75
8.14.1	Aspirating the sample tube manually .....	75
8.14.2	Aspirating the receiving vessel manually .....	76
8.15	Changing the stirring speed manually .....	76
<b>9</b>	<b>Carrying out a determination .....</b>	<b>78</b>
9.1	Preparing the instrument .....	78
9.2	Starting a determination .....	78
9.3	Ending a determination .....	79
9.4	Shutting down the instrument .....	79
9.5	Filtering determination data .....	79
9.6	Showing determination data .....	79
9.7	Deleting determination data .....	79
9.7.1	Deleting one determination .....	79
9.7.2	Deleting all determination data .....	80
9.8	Exporting determination data (Interface pro only) .....	80
9.8.1	Exporting one determination (Interface pro only) .....	80
9.8.2	Exporting all determination data (Interface pro only) .....	80

<b>10</b>	<b>Cleaning and servicing</b> .....	<b>81</b>
10.1	Regular maintenance work .....	82
10.2	Cleaning and servicing the sample tube .....	82
10.3	Cleaning the glass components .....	83
10.4	Cleaning and servicing the hoses and hose connections .....	83
10.5	Cleaning and servicing the sample tube seal .....	83
10.6	Cleaning and servicing the splash protector .....	84
10.7	Cleaning and servicing the steam inlet and condenser outlet tube .....	84
10.8	Cleaning the housing .....	84
10.9	Cleaning and servicing the warning and directive symbols .....	84
10.10	Cleaning and servicing the bridge splash protector to condenser .....	84
10.11	Cleaning and servicing the dosing pumps .....	84
10.12	Cleaning and servicing the condenser .....	84
10.13	Cleaning and servicing the steam generator .....	85
10.14	Calibrating the pumps .....	85
	10.14.1 Calibrating the H <sub>2</sub> O pump .....	85
	10.14.2 Calibrating the acid pump .....	86
	10.14.3 Calibrating the NaOH pump .....	86
	10.14.4 Calibrating the H <sub>3</sub> BO <sub>3</sub> Pump .....	87
10.15	Decalcifying the instrument .....	87
10.16	Replacing the splash protector .....	88
10.17	Replacing the condenser .....	89
10.18	Attaching and removing the protection shield .....	89
	10.18.1 Removing the protection shield .....	89
	10.18.2 Attaching the protection shield .....	90
10.19	Cleaning the drip tray .....	90
10.20	Rinsing a pump .....	90
10.21	Replacing the sample tube seal .....	90
<b>11</b>	<b>Help with faults</b> .....	<b>92</b>
11.1	Troubleshooting digestion .....	92
11.2	Troubleshooting distillation .....	93
11.3	Troubleshooting instrument .....	95
11.4	Turning the splash protector nut .....	97
<b>12</b>	<b>Taking out of service and disposal</b> .....	<b>98</b>
12.1	Taking out of service .....	98
12.2	Disposal .....	98
12.3	Returning the instrument .....	98
12.4	Removing water from the steam generator .....	98

---

<b>13</b>	<b>Appendix .....</b>	<b>99</b>
13.1	Spare parts and accessories .....	99
13.1.1	Accessories .....	99
13.1.2	Splash protector spare parts .....	100
13.1.3	Tank spare parts.....	101
13.1.4	Condenser spare parts .....	101
13.1.5	Titration spare parts.....	102
13.1.6	Sample tubes.....	103
13.1.7	Cable and tubing .....	103
13.1.8	Other spare parts.....	104
13.1.9	Consumables.....	104
13.1.10	Maintenance kit .....	104
13.1.11	Upgrade kits .....	104
13.1.12	Documentation .....	105



# 1 About this document

This operation manual is applicable for all variants of the instrument.

Read this operation manual before operating the instrument and follow the instructions to ensure safe and trouble-free operation.

Keep this operation manual for later use and pass it on to any subsequent user or owner.

BÜCHI Labortechnik AG accepts no liability for damage, faults and malfunctions resulting from not following this operation manual.

If you have any questions after reading this operation manual:

- ▶ Contact BÜCHI Labortechnik AG Customer Service.

<https://www.buchi.com/contact>

## 1.1 Mark-ups and symbols



### NOTE

This symbol draws attention to useful and important information.

- ☑ This character draws attention to a requirement that must be met before the instructions below are carried out.
- ▶ This character indicates an instruction that must be carried out by the user.
- ⇒ This character indicates the result of a correctly carried out instruction.

Mark-up	Explanation
<i>Window</i>	Software Windows are marked-up like this.
<i>Tab</i>	Tabs are marked-up like this.
<i>Dialog</i>	Dialogs are marked-up like this.
<i>[Button]</i>	Buttons are marked-up like this.
<i>[Field names]</i>	Field names are marked-up like this.
<i>[Menu / Menu item]</i>	Menus or menu items are marked-up like this.
<b>Status</b>	Status is marked-up like this.
<b>Signal</b>	Signals are marked-up like this.

## 1.2 Trademarks

Product names and registered or unregistered trademarks that are used in this document are used only for identification and remain the property of the owner in each case.

## 1.3 Connected devices

In addition to these operating instructions, follow the instructions and specifications in the documentation for the connected devices.

## 2 Safety

### 2.1 Proper use

The instrument is designed for steam distillation.

The instrument can be used in laboratories for the following tasks:

- Distillation of steam-volatile substances.

### 2.2 Use other than that intended

The use of the instrument other than described in proper use and specified in technical data is use other than that intended.

The operator is responsible for damages or hazards that are caused by use other than that intended.

Specially the following uses are not permitted:

- Use of the instrument in areas which require explosion-safe instruments.
- Use of samples, which can explode or inflame (example: explosives, etc.) due to shock, friction, heat or spark formation.
- Use of the instrument with other than original BUCHI glassware.

### 2.3 Staff qualification

Unqualified persons are unable to identify risks and are therefore exposed to greater dangers.

The device may only be operated by suitably qualified laboratory staff.

These operating instructions are aimed at the following target groups:

#### Users

Users are persons that meet the following criteria:

- They have been instructed in the use of the device.
- They are familiar with the contents of these operating instructions and the applicable safety regulations and apply them.
- They are able on the basis of their training or professional experience to assess the risks associated with the use of the device.

#### Operator

The operator (generally the laboratory manager) is responsible for the following aspects:

- The device must be correctly installed, commissioned, operated and serviced.
- Only suitably qualified staff may be assigned the task of performing the operations described in these operating instructions.
- The staff must comply with the local applicable requirements and regulations for safe and hazard-conscious working practices.
- Safety-related incidents that occur while using the device should be reported to the manufacturer (quality@buchi.com).

### BUCHI service technicians

Service technicians authorized by BUCHI have attended special training courses and are authorized by BÜCHI Labortechnik AG to carry out special servicing and repair measures.

## 2.4 Personal protective equipment

Depending on the application, hazards due to heat and/or corrosive chemicals may arise.

- ▶ Always wear appropriate personal protective equipment such as safety goggles, protective clothing and gloves.
- ▶ Make sure that the personal protective equipment meets the requirements of the safety data sheets for all chemicals used.





## 2.5 Warning notices in this document

Warning notices warn you of dangers that can occur when handling the device. There are four danger levels, each identifiable by the signal word used.

Signal word	Meaning
DANGER	Indicates a danger with a high level of risk which could result in death or serious injury if not prevented.
WARNING	Indicates a danger with a medium level of risk which could result in death or serious injury if not prevented.
CAUTION	Indicates a danger with a low level of risk which could result in minor or medium-severity injury if not prevented.
NOTICE	Indicates a danger that could result in damage to property.

## 2.6 Warning and directive symbols

The following warning and directive symbols are displayed in this operation manual or on the instrument.

Symbol	Meaning
	Hot surface
	Corrosive
	General warning
	Device damage
	Dangerous electrical voltage

Symbol	Meaning
	Wear protective gloves
	Wear safety goggles

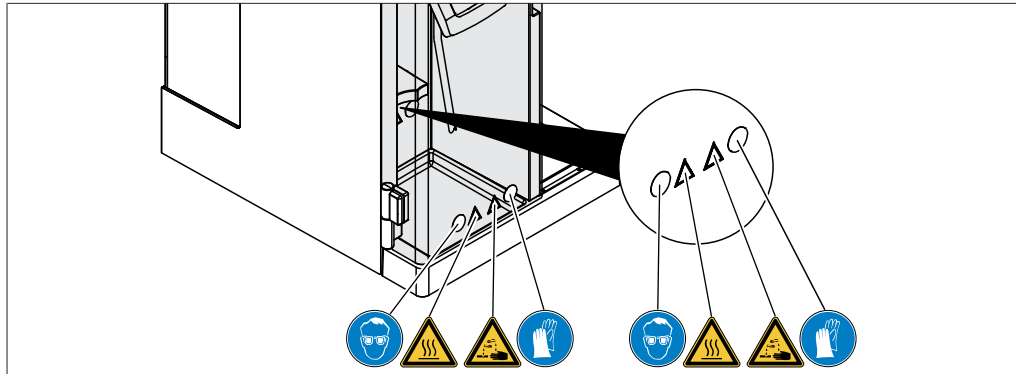

Fig. 1: Location of the warning and directive symbols

## 2.7 Protection devices

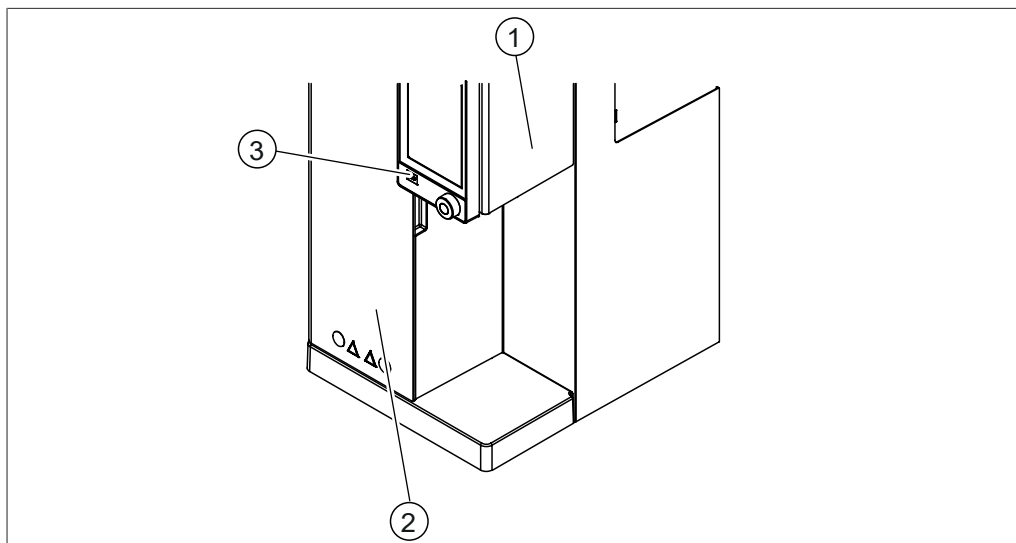

Fig. 2: Protection devices

- |                     |                     |
|---------------------|---------------------|
| 1 Protection shield | 2 Protection shield |
| 3 Stop button       |                     |

## 2.8 Residual risks

The device has been developed and manufactured using the latest technological advances. Nevertheless, risks to persons, property or the environment can arise if the device is used incorrectly.

Appropriate warnings in this manual serve to alert the user to these residual dangers.

### 2.8.1 Hot surfaces

The surfaces of the device can become very hot. If touched they can cause skin burns.

- ▶ Do not touch hot surfaces or else wear suitable protective gloves.

### 2.8.2 Faults during operation

If a device is damaged, sharp edges, moving parts or exposed electrical wires can cause injuries.

- ▶ Regularly check device for visible damage.
- ▶ If faults occur, switch off the device immediately, unplug the power cord and inform the operator.
- ▶ Do not continue to use devices that are damaged.

### 2.8.3 Glass breakage

Broken glass can cause severe cuts.

Minor damage to the ground joints impairs the sealing effect and may therefore diminish suction capacity.

- Handle the glass components carefully and do not drop them.
- Always place the glassware in a suitable holder when they are not in use.
- Always visually inspect glass components for damage every time they are to be used.
- Do not continue to use glass components that are damaged.
- Always wear protective gloves when disposing of broken glass.

### 2.8.4 Not suitable titrators

Not suitable titrators can lead to malfunction and wrong results.

- ▶ Use recommended titrators only.

### 2.8.5 Dosing pump defect

A defect dosing pump can spill hazardous liquids on the installation site.

- ▶ Set the On / Off master switch to Off.
- ▶ Disconnect the power supply.
- ▶ Use personal protective equipment to remove the liquid.
- ▶ Dispose of the remains of the liquid according to the local legal regulations.

## 2.9 Modifications

Unauthorized modifications can effect safety and lead to accidents.

- ▶ Use only genuine BUCHI accessories, spare parts and consumables.
- ▶ Carry out technical changes only with prior written approval from BUCHI.
- ▶ Only allow changes to be made by BUCHI service technicians.

BUCHI accepts no liability for damage, faults and malfunctions resulting from unauthorized modifications.

## 3 Product description

### 3.1 Description of function

The instrument is suitable for determining nitrogen using the Kjeldahl (TKN; Total Kjeldahl Nitrogen) and Devarda methods as well as for other distillations of steam-volatile substances (e.g. of alcohol).

- Steam is introduced into the sample solution to drive out volatile components (such as ammonia, alcohol, etc.).
- After condensation in the condenser the condensate is collected in a receiver solution in the receiving vessel.

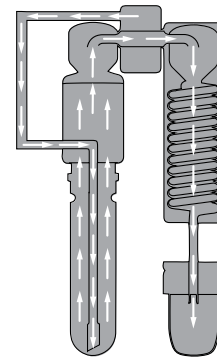

### 3.2 Configuration

#### 3.2.1 Front view



#### NOTE

The interface differs according to the configuration:

- ▶ Interface (Chapter 6 "Description of the interface", page 39)  
⇒ EasyKjel, BasicKjel (option)
- ▶ Interface Pro (Chapter 7 "Description of the interface pro", page 45)  
⇒ BasicKjel (option), MultiKjel, MultiKjel T

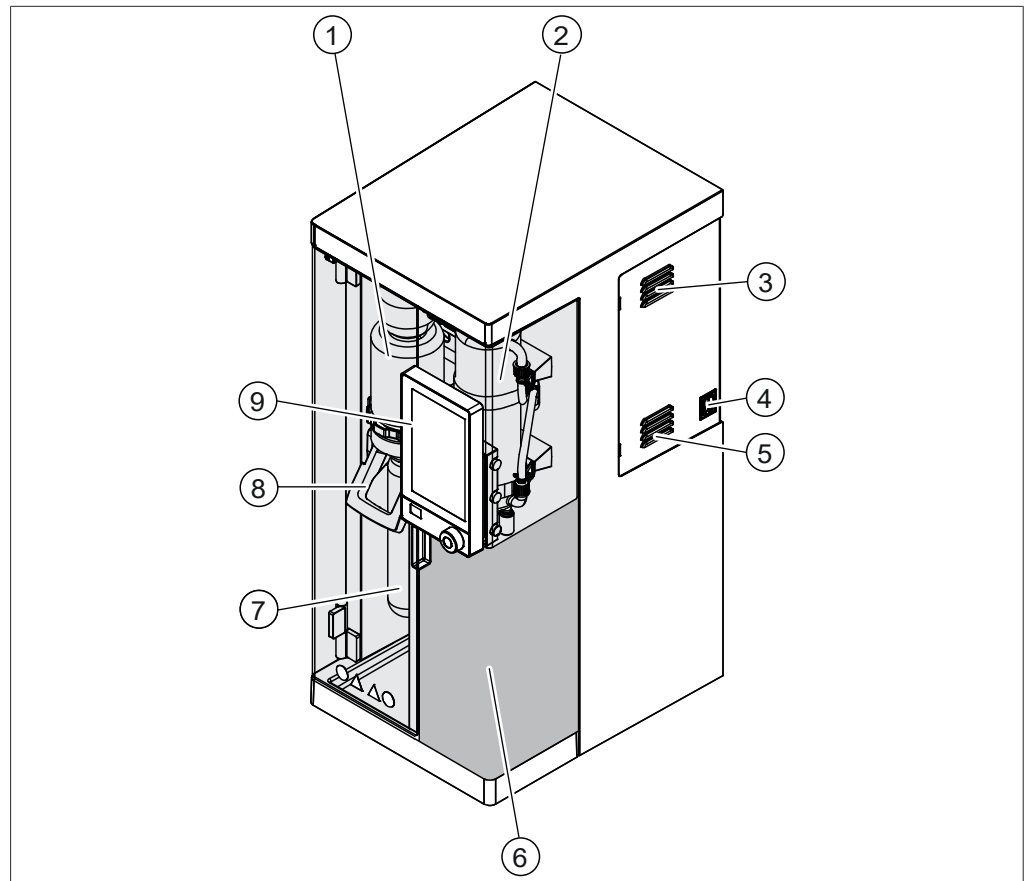

Fig. 3: Front view

- |   |  |   |  |
|---|--|---|--|
| 1 | Splash protector   | 2 | Condenser  |
| 3 | Ventilation slots  | 4 | On/Off master switch   |
| 5 | Ventilation slots  | 6 | Receiving area<br>See Chapter 3.2.3 "Receiving area",<br>page 16 |
| 7 | Sample tube  | 8 | Handle   |
| 9 | Interface<br>(according to the instrument configuration) |   |  |

### 3.2.2 Rear view

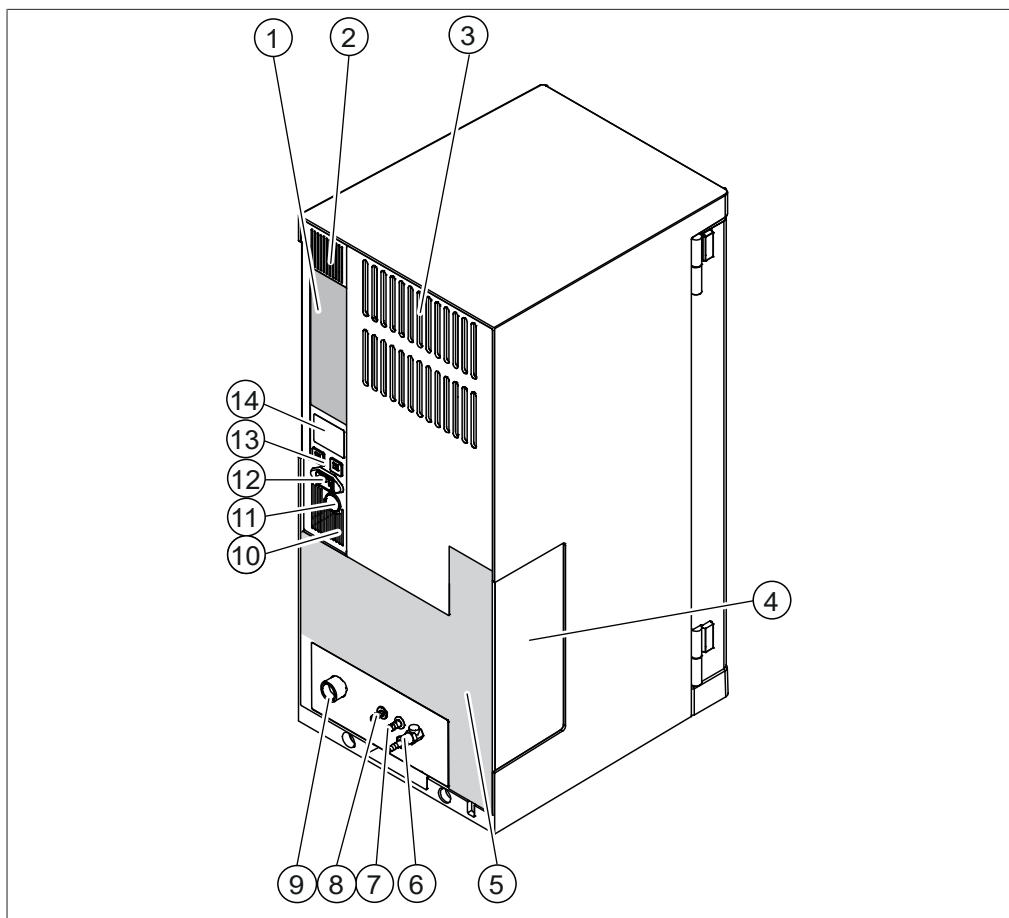

Fig. 4: Rear view

- |    |   |    |   |
|----|---|----|---|
| 1  | Communication connections<br>See Chapter 3.2.4 "Communication connections", page 18       | 2  | Ventilation slots   |
| 3  | Ventilation slots   | 4  | Dosing pumps window   |
| 5  | Connections on the rear side<br>See Chapter 3.2.5 "Connections on the rear side", page 20 | 6  | Steam valve   |
| 7  | Cooling water out   | 8  | Drain connection<br>(according to the instrument configuration) |
| 9  | Cooling water in  | 10 | Ventilation slots   |
| 11 | Rear cable duct   | 12 | Power supply connection   |
| 13 | Fuses<br>(resettable)   | 14 | Type plate<br>See Chapter 3.4 "Type plate", page 24             |

### 3.2.3 Receiving area

The receiving area is different for each instrument configuration.



## Receiving area

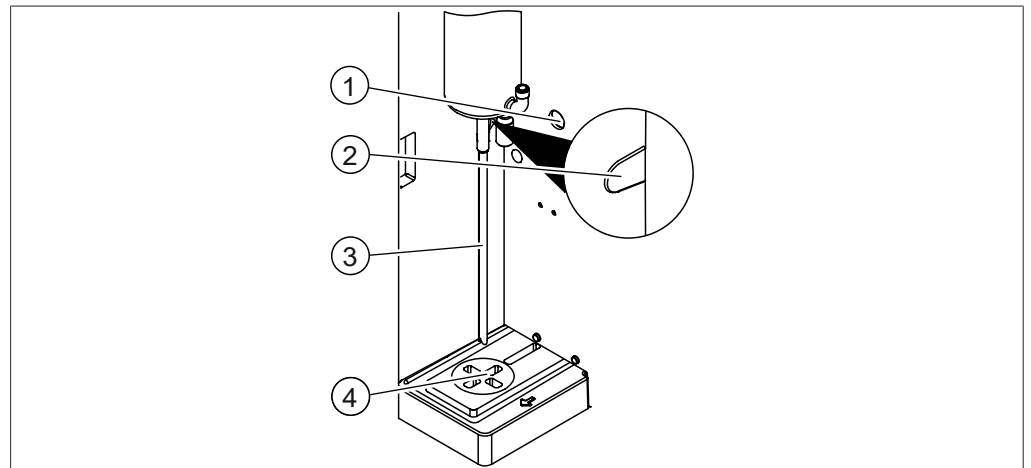

Fig. 5: Receiving area

- |   |                  |   |                                      |
|---|------------------|---|--------------------------------------|
| 1 | Rear cable duct  | 2 | Cable duct reaction detection sensor |
| 3 | Condenser outlet | 4 | Receiving vessel area                |

## Receiving area (MultiKjel T only)

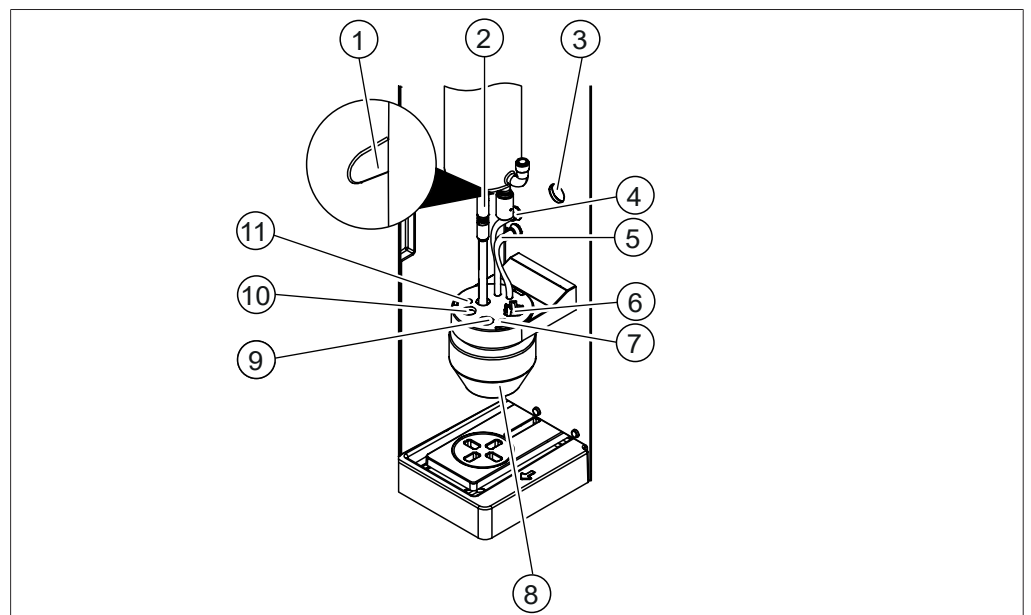

Fig. 6: Receiving area

- |    |                                      |    |                                  |
|----|--------------------------------------|----|----------------------------------|
| 1  | Cable duct reaction detection sensor | 2  | Condenser outlet tubing          |
| 3  | Rear cable duct                      | 4  | Tubing for boric acid aspiration |
| 5  | Boric acid dosing                    | 6  | Retainer stirrer                 |
| 7  | Retainer dosing tip titration        | 8  | Receiving vessel                 |
| 9  | Retainer titration sensor            | 10 | Retainer temperature sensor      |
| 11 | Retainer dosing tip back titration   |    |                                  |

### 3.2.4 Communication connections

#### Communication connection EasyKjel

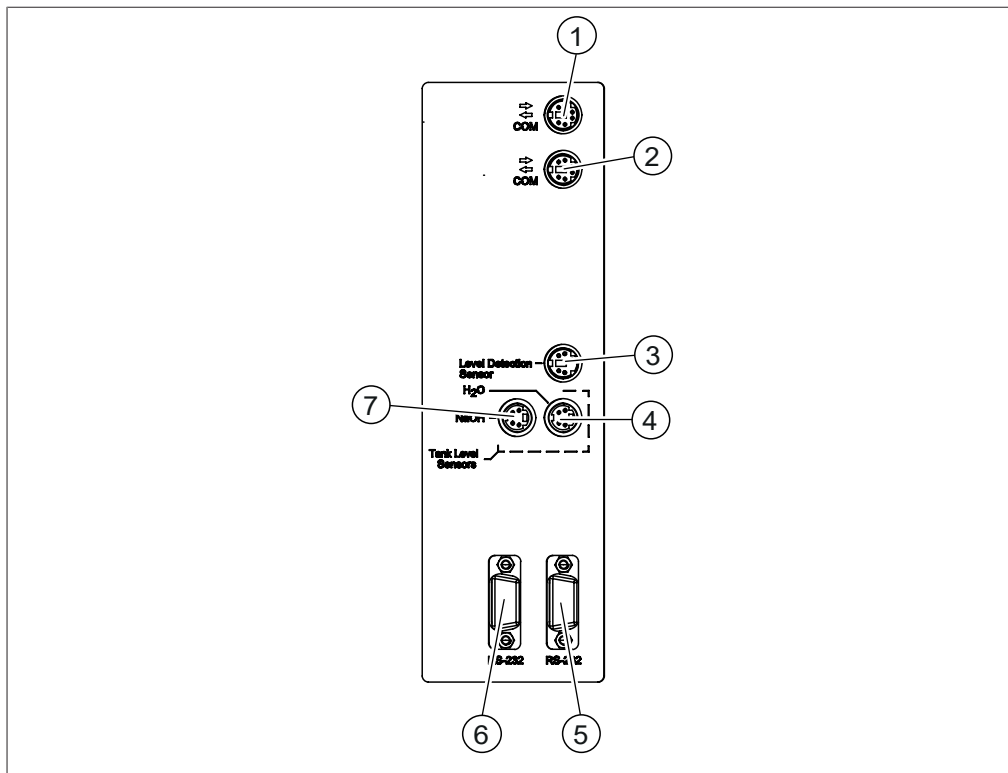

Fig. 7: Communication connections

- |   |  |   |   |
|---|--|---|---|
| 1 | BUCHI standard communication port (COM) (marked <b>COM</b> ) | 2 | BUCHI standard communication port (COM) (marked <b>COM</b> )            |
| 3 | Level detection sensor port (marked <b>Level Detection</b> ) | 4 | H <sub>2</sub> O tank level sensor port (marked <b>H<sub>2</sub>O</b> ) |
| 5 | Communication port (marked <b>RS-232</b> )                   | 6 | Communication port (marked <b>RS-232</b> )                              |
| 7 | NaOH tank level sensor port (marked <b>NaOH</b> )            |   |   |

## Communication connection BasicKjel

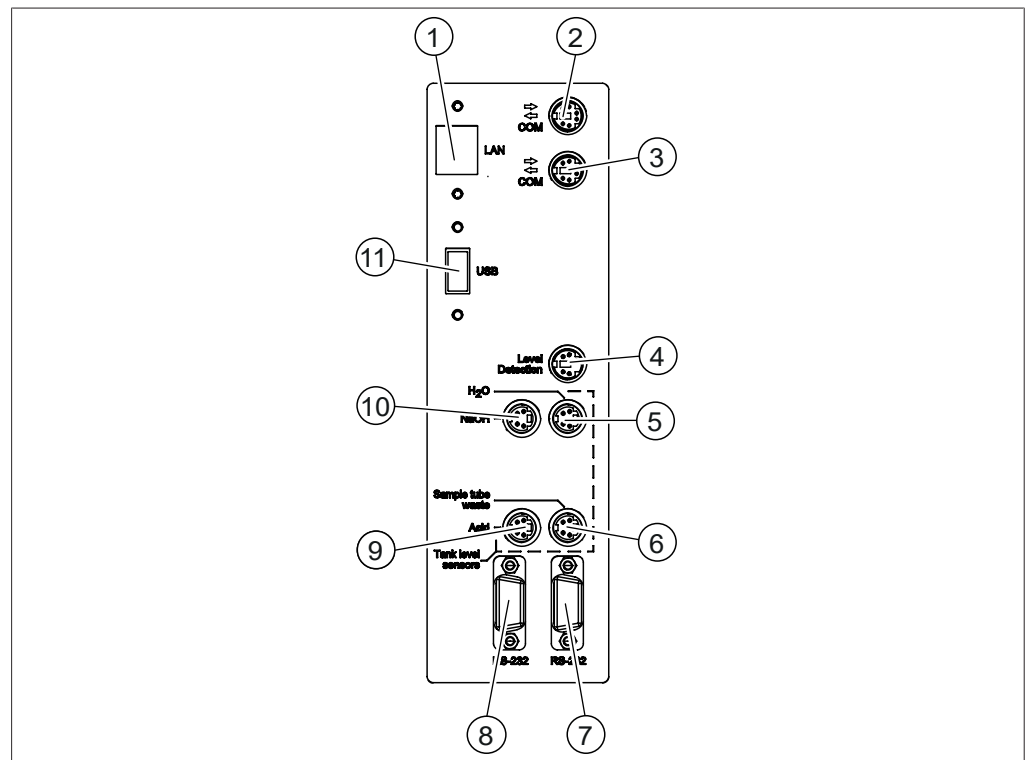

Fig. 8: Communication connection

- |  |  |
|--|--|
| 1 LAN port<br>(marked <b>LAN</b> )   | 2 BUCHI standard communication port<br>(COM)<br>(marked <b>COM</b> ) |
| 3 BUCHI standard communication port<br>(COM)<br>(marked <b>COM</b> )         | 4 Level detection sensor port<br>(marked <b>Level Detection</b> )    |
| 5 H <sub>2</sub> O tank level sensor port<br>(marked <b>H<sub>2</sub>O</b> ) | 6 Waste tank level sensor port<br>(marked <b>Sample Tube Waste</b> ) |
| 7 Communication port<br>(marked <b>RS-232</b> )                              | 8 Communication port<br>(marked <b>RS-232</b> )                      |
| 9 Acid tank level sensor port<br>(marked <b>Acid</b> )                       | 10 NaOH tank level sensor port<br>(marked <b>NaOH</b> )              |
| 11 USB port<br>(marked <b>USB</b> )  |  |

## Communication connection MultiKjel

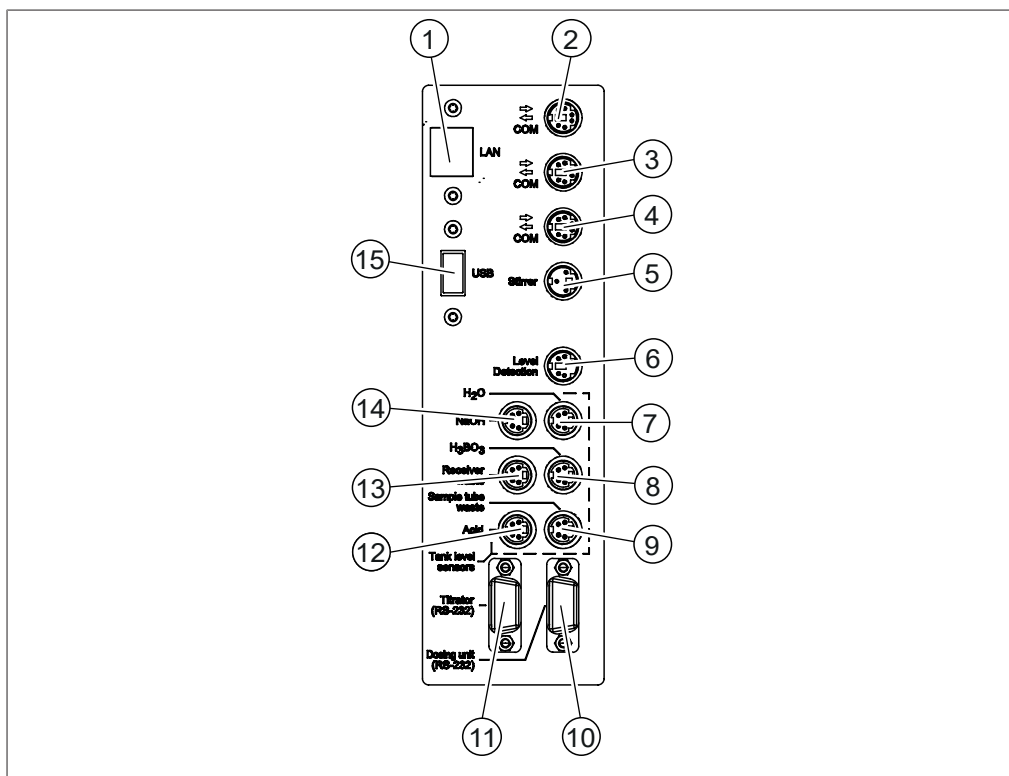

Fig. 9: Communication connections

- |  |   |
|--|---|
| 1 LAN port<br>(marked <b>LAN</b> )   | 2 BUCHI standard communication port<br>(COM)<br>(marked <b>COM</b> )                                    |
| 3 BUCHI standard communication port<br>(COM)<br>(marked <b>COM</b> )         | 4 BUCHI standard communication port<br>(COM)<br>(marked <b>COM</b> )                                    |
| 5 Stirrer port<br>(marked <b>Stirrer</b> )                                   | 6 Level detection sensor port<br>(marked <b>Level Detection</b> )                                       |
| 7 H <sub>2</sub> O tank level sensor port<br>(marked <b>H<sub>2</sub>O</b> ) | 8 H <sub>3</sub> BO <sub>3</sub> tank level sensor port<br>(marked <b>H<sub>3</sub>BO<sub>3</sub></b> ) |
| 9 Waste tank level sensor port<br>(marked <b>Sample Tube Waste</b> )         | 10 Dispenser port<br>(marked <b>Dosing Unit</b> )   |
| 11 Titrator port<br>(marked <b>Titrator</b> )                                | 12 Acid tank level sensor port<br>(marked <b>Acid</b> )   |
| 13 Waste tank level sensor port<br>(marked <b>Receiver Waste</b> )           | 14 NaOH tank level sensor port<br>(marked <b>NaOH</b> )   |
| 15 USB port<br>(marked <b>USB</b> )  |   |

### 3.2.5 Connections on the rear side

The connections on the rear side are depending on the version of the instrument.

### Connections on the rear side EasyKjel

The connections are located at the rear side of the instrument. See Chapter 3.2.2 "Rear view", page 16

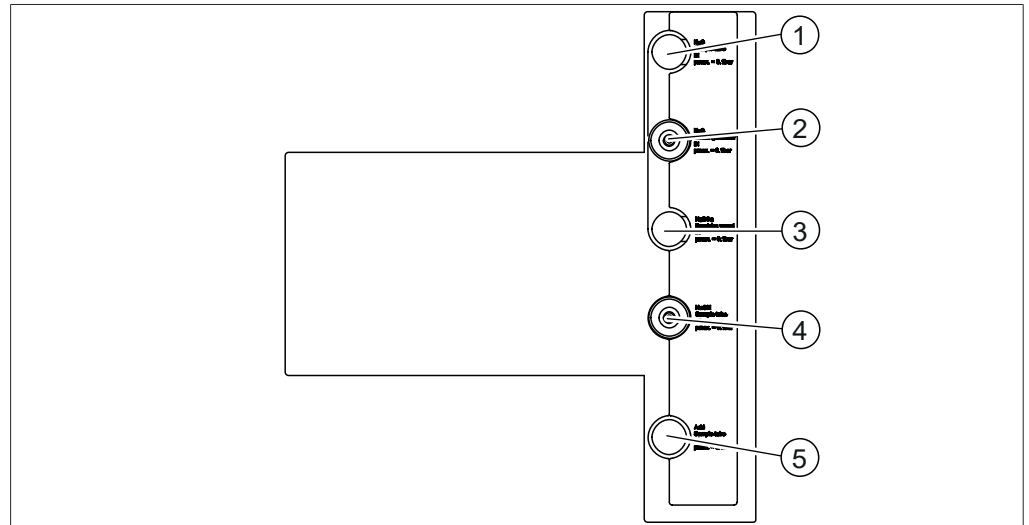

Fig. 10: Connections on the rear side

- |   |         |   |  |
|---|---------|---|--|
| 1 | Reserve | 2 | H <sub>2</sub> O supply for steam generation |
| 3 | Reserve | 4 | Reserve                                      |
| 5 | Reserve |   |  |

### Connections on the rear side BasicKjel (option)

The connections are located at the rear side of the instrument. See Chapter 3.2.2 "Rear view", page 16

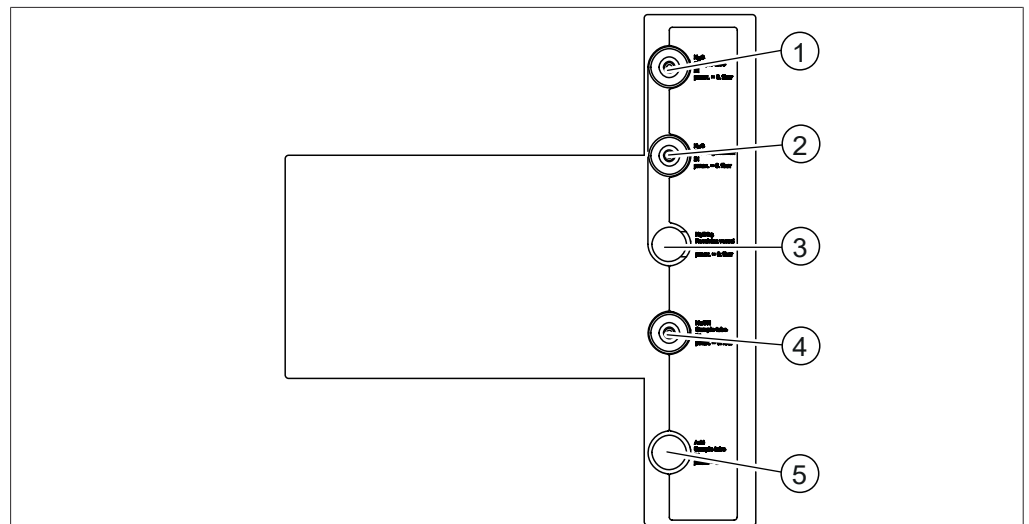

Fig. 11: Connections on the rear side

- |   |   |   |  |
|---|---|---|--|
| 1 | H <sub>2</sub> O supply for sample tube | 2 | H <sub>2</sub> O supply for steam generation |
| 3 | Reserve                                 | 4 | Acid supply for sample tube                  |
| 5 | Reserve                                 |   |  |

### Connections on the rear side BasicKjel (option)

The connections are located at the rear side of the instrument. See Chapter 3.2.2 "Rear view", page 16

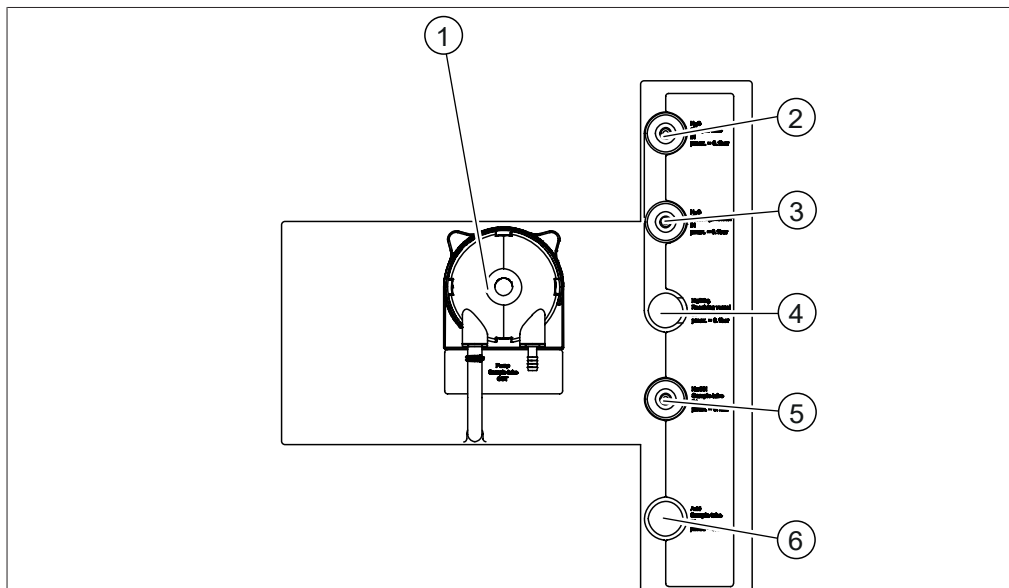

Fig. 12: Connections on the rear side

- |   |  |   |   |
|---|--|---|---|
| 1 | Waste pump                                   | 2 | H <sub>2</sub> O supply for sample tube |
| 3 | H <sub>2</sub> O supply for steam generation | 4 | Reserve                                 |
| 5 | Acid supply for sample tube                  | 6 | Reserve                                 |

### Connections on the rear side MultiKjel

The connections are located at the rear side of the instrument. See Chapter 3.2.2 "Rear view", page 16

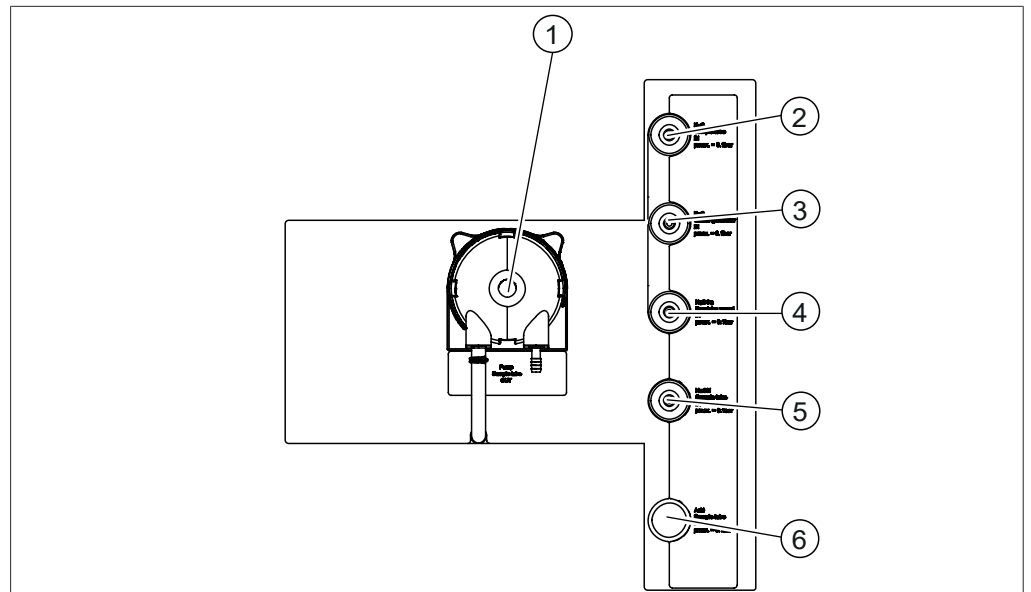

Fig. 13: Connections on the rear side

- |  |   |
|--|---|
| 1 Waste pump for sample tube                   | 2 H <sub>2</sub> O supply for sample tube |
| 3 H <sub>2</sub> O supply for steam generation | 4 Boric acid supply                       |
| 5 NaOH supply for sample tube                  | 6 Reserve                                 |

### Connections on the rear side MultiKjel T

The connections are located at the rear side of the instrument. See Chapter 3.2.2 "Rear view", page 16

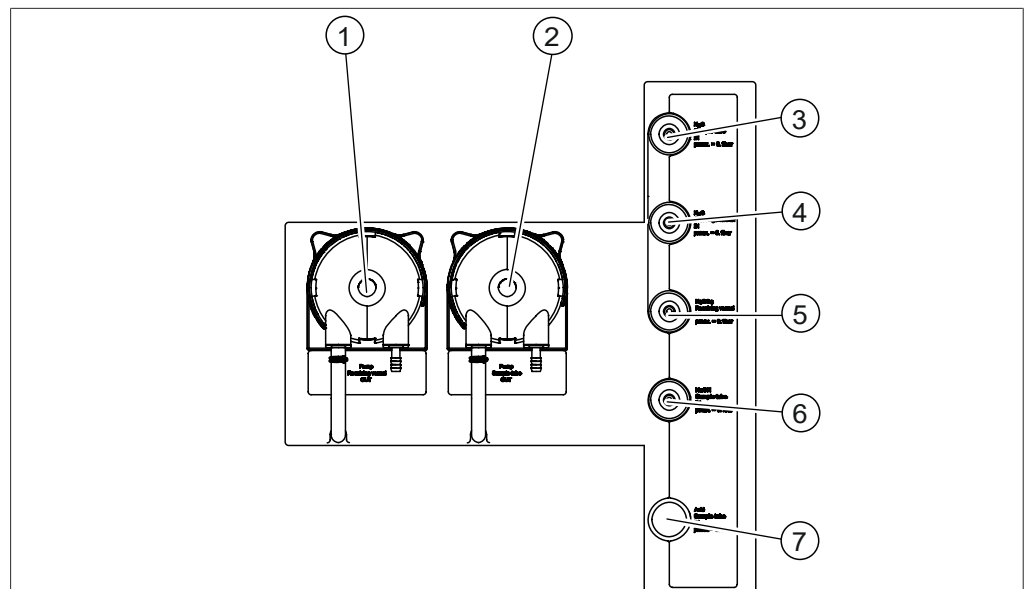

Fig. 14: Connections on the rear side

- |   |  |
|---|--|
| 1 Waste pump receiving vessel             | 2 Waste pump for sample tube                   |
| 3 H <sub>2</sub> O supply for sample tube | 4 H <sub>2</sub> O supply for steam generation |
| 5 Boric acid supply                       | 6 NaOH supply for sample tube                  |
| 7 Reserve                                 |  |

### 3.3 Scope of delivery



#### NOTE

The scope of delivery depends of the configuration of the purchase order.

Accessories are delivered as per the purchase order, order confirmation, and delivery note.

### 3.4 Type plate

The type plate identifies the instrument. The type plate is located at the rear of the instrument.

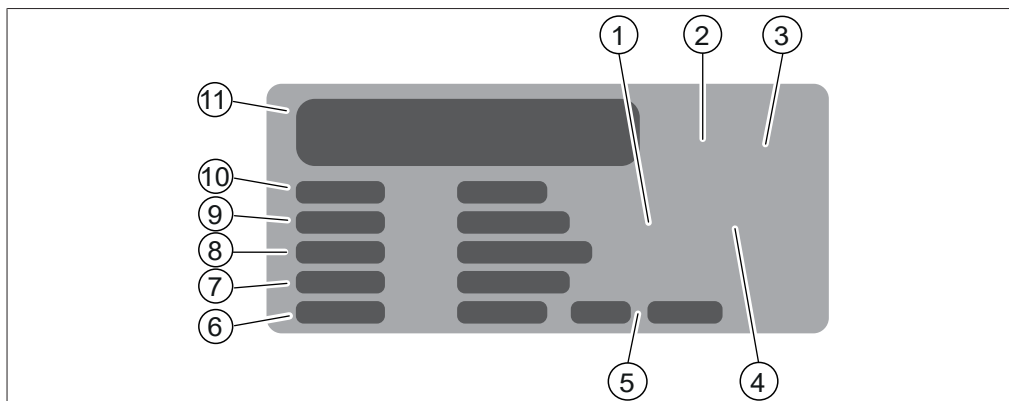

Fig. 15: Type plate

- |    |                                    |    |   |
|----|------------------------------------|----|---|
| 1  | Symbol for "electronics recycling" | 2  | Initial product code                              |
| 3  | Approvals                          | 4  | Symbol for "Do not dispose of as household waste" |
| 5  | Year of manufacture                | 6  | Power consumption maximum                         |
| 7  | Frequency                          | 8  | Input voltage range                               |
| 9  | Serial number                      | 10 | Instrument name                                   |
| 11 | Company name and address           |    |   |

### 3.5 Technical data

#### 3.5.1 K-365 Kjel Line

	EasyKjel	BasicKjel	MultiKjel
Dimensions (W x D x H)	320 x 400 x 730 mm	320 x 400 x 730 mm	320 x 400 x 730 mm
Weight	23 kg	23 kg	23 kg
Connection voltage	220 - 240 ± 10 % VAC	220 - 240 ± 10 % VAC	220 - 240 ± 10 % VAC
Power consumption	2100 W	2100 W	2100 W
Frequency	50 / 60 Hz	50 / 60 Hz	50 / 60 Hz
IP Code	IP20	IP20	IP20
Pollution degree	2	2	2
Overvoltage category	II	II	II



	EasyKjel	BasicKjel	MultiKjel
Tap water pressure	1 - 10 bar	1 - 10 bar	1 - 10 bar
Tap water condition (If the temperature is more than 25°C use a recirculating chiller)	1- 25°C	1 - 25°C	1 - 25°C
Tap water consumption	~ 1.2 L/min	~ 1.2 L/min	~ 1.2 L/min
Approvals	CE, CSA	CE, CSA	CE, CSA

### Analysis specifications

	EasyKjel	BasicKjel	MultiKjel
Measuring range N	0.02 – 220 mg	0.02 – 220 mg	0.02 – 220 mg
Analysis time for 30 mg N (With Metrohm Eco Titrator without titrator preparation)	-	-	3.5 min
Analysis time for 200 mg N (With Metrohm Eco Titrator without titrator preparation)	-	-	5 min
Recovery	N: >98% with digestion process N: >99.5% (direct distillation)	N: >98% with digestion process N: >99.5% (direct distillation)	N: >98% with digestion process N: >99.5% (direct distillation)
Measurement reproducibility (Direct distillation of 1 mg N absolute and 300 sec. distillation)	< 0.8 %	< 0.8 %	< 0.8 %

### Instrument specifications

	EasyKjel	BasicKjel	MultiKjel
Distillation capacity (100%)	~ 40 mL/min	~ 40 mL/min	~ 40 mL/min
Distillation capacity (10%)	~ 12.5 mL/min	~ 12.5 mL/min	~ 12.5 mL/min
Adjustable distillation power	10 - 100%	10 - 100%	10 - 100%
MaxAccuracy Mode (Compensation of power grid fluctuations)	Yes	Yes	Yes
Distillate reproducibility (RSD) (At 300 seconds distillation time)	<1%	<1%	<1%
AutoDist Mode (Automatic detection of the condensation start)	No	Yes	Yes
NaOH pump	Yes	Yes	Yes
H <sub>2</sub> O pump	No	Yes	Yes
Acid pump	No	No	No

	EasyKjel	BasicKjel	MultiKjel
Boric acid pump	No	No	Yes
Sample disposal	No	Optional	Yes
Receiver disposal	No	No	Optional
Safety sensors	Yes	Yes	Yes
Titration vessel	No	No	Optional
Titration connection	No	No	Optional

### Interface specifications

	Interface EasyDist, BasicDist	Interface pro BasicDist (option), MultiDist
Display	LCD color, 4.3 in	LCD color, 7.0 in
Control elements	Buttons / control knob	Touch-screen / control knob
Max. number of methods	8	96
Max. number of determinations	36	512
Max. number of determinations per series	16	32
Max. number of templates	4	16
Max. number of users	4	32
Max. number of determination results	40	256
Language	en, de, fr, it, es, pt, ja, zh, ru, pl, ko, id	en, de, fr, it, es, pt, ja, zh, ru, pl, ko, id

### 3.5.2 Ambient conditions

For indoor use only.

Max. altitude above sea level	2000 m
Ambient and storage temperature	5–40 °C
Maximum relative humidity	80% for temperatures up to 31 °C decreasing linearly to 50 % relative humidity at 40 °C

### 3.5.3 Materials

Component	Materials of construction
Housing	Polyurethane
Housing electric	Stainless steel
Steam generator housing	Stainless steel
Housing stirrer	Glass fiber reinforced polypropylene
Rear cover	Polyvinyl chloride
Glass parts	Borosilicate 3.3

<b>Component</b>	<b>Materials of construction</b>
Plastic splash protector	Glass fiber reinforced polypropylene
Protective cover	PMMA
Sealing	CSM
NaOH hose	EPDM
Three-way valve	PP / PE

### 3.5.4 Installation site

- The installation site meets the safety requirements. See Chapter 2 "Safety", page 10
- The installation site has a firm, level and nonslip surface.
- The installation site has no obstacles (e.g. water taps, drains, etc.).
- The installation site has enough space that the canisters can be placed safely.
- The installation site has an own mains outlet socket for the instrument.
- The installation site allows that the power supply can be disconnected at any time in an emergency.
- The installation site is not exposed to external thermal loads, such as direct solar radiation.
- The installation site has enough space that cables / tubes can be routed safely.
- The installation site meets the requirements for the connected devices. See related documentation
- The installation site meets the specifications according to the technical data (e.g. weight, dimension, etc.). See Chapter 3.5 "Technical data", page 24

## 4 Transport and storage

### 4.1 Transport



#### NOTICE

##### Risk of breakage due to incorrect transportation

Make sure that the instrument is fully dismantled.

Pack every instrument components properly to prevent breakage. Use the original packaging whenever possible.

Avoid sharp movements during transit.

- ▶ After transporting, check the instrument and all glass components for damage.
- ▶ Damage that has occurred in transit should be reported to the carrier.
- ▶ Keep packaging for future transportation.

### 4.2 Storage

- ▶ Make sure that the ambient conditions are complied with (see Chapter 3.5 "Technical data", page 24).
- ▶ Wherever possible, store the device in its original packaging.
- ▶ After storage, check the device, all glass components, seals and tubing for damage and replace if necessary.

### 4.3 Lifting the instrument



#### NOTICE

##### Dragging the instrument can damage the feet of the instrument.

- ▶ Lift the instrument when positioning or re-locating.

- ▶ Lift the instrument at the points indicated.

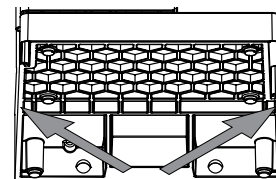

## 5 Installation

### 5.1 Before installation



#### NOTICE

##### Instrument damage due to switching it on too early.

Switching on the instrument too early after transportation can cause damage.

- ▶ Climatize the instrument after transportation.

### 5.2 Establishing electrical connections



#### NOTICE

##### Risk of instrument damage because of not suitable power supply cables.

Not suitable power supply cables can cause bad performance or an instrument damage

- ▶ Use only BUCHI power supply cables.

Precondition:

- The electrical installation is as specified on the type plate.
  - The electrical installation is equipped with a proper grounding system.
  - The electrical installation is equipped with suitable fuses and electrical safety features.
  - The installation site is as specified in the technical data. See Chapter 3.5 "Technical data", page 24
- ▶ Connect the power supply cable to the connection on the instrument. See Chapter 3.2 "Configuration", page 14

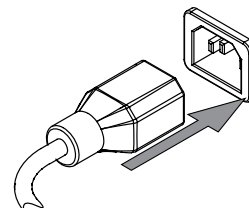

- ▶ Connect the mains plug to an own mains outlet socket.

### 5.3 Securing against earthquakes

The instrument has an earthquake fixing point to protect the device against falling.

- ▶ Tie the lashing mount to a fixed point using strong cord or a wire.

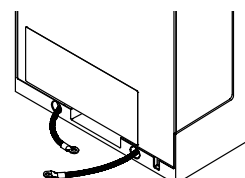

## 5.4 Installing the cooling water supply

### 5.4.1 Installing a tap water supply (option)

Precondition:

- ☑ The tap water supply complies with the specified parameters. See Chapter 3.5 "Technical data", page 24
- ☑ Make sure that the instrument is not connected to the power supply.
- ▶ Install the inlet hose to the connection marked **Cooling Water / Chiller IN.**
- ▶ Install the drain hose to the connection marked **OUT Cooling Water / Chiller.**

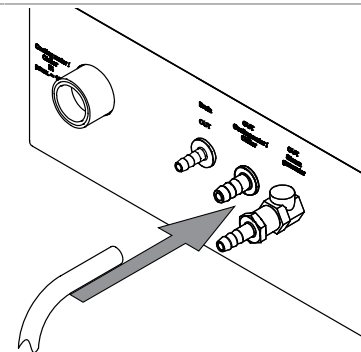
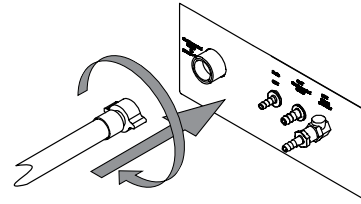

- ▶ Put the other end of the hose in a sink.

### 5.4.2 Installing the recirculating chiller on the condenser (option)



#### NOTE

Place the hose in the rear cable duct.

Precondition:

- ☑ The water supply complies with the tap water specifications. See Chapter 3.5 "Technical data", page 24
- ▶ Make sure that the instrument is not connected to the power supply.
- ▶ Remove the connection at the condenser inlet.
- ▶ Attach the cooling water hose from the chiller to the condenser.

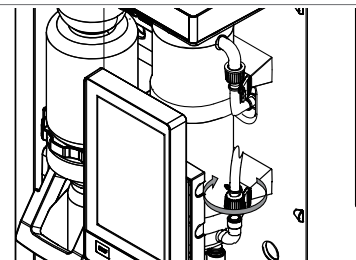
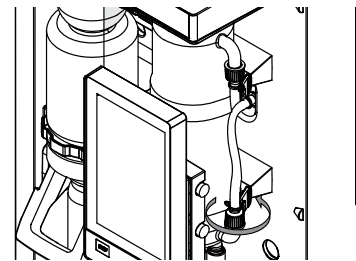

- ▶ Install the drain hose to the connection marked **OUT Cooling Water / Chiller** on the rear of the instrument.

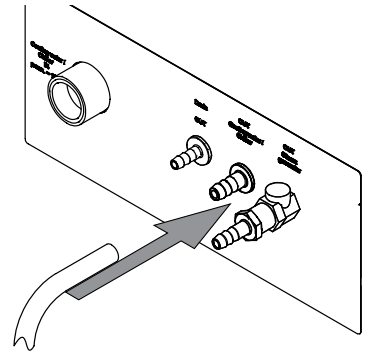

- ▶ Make sure that the hoses are not bend.

## 5.5 Installing the drain tubing (option)

- ▶ Install the drain hose to the connection marked **Drain**.
- ▶ Place the other end of the hose in an aqueous waste container located lower than the instrument.

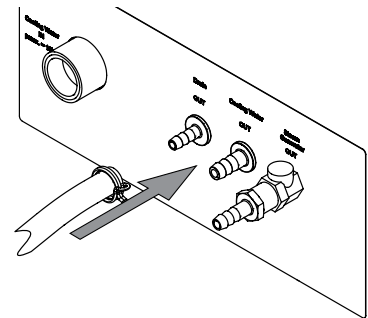

## 5.6 Installing the waste pump connection (Basickjel, MultiKjel, MultiKjel T only)

- ▶ Attach the waste hose onto the connection marked **Pump Receiving Vessel OUT**.
- ▶ Secure the hose in place with a hose clip.

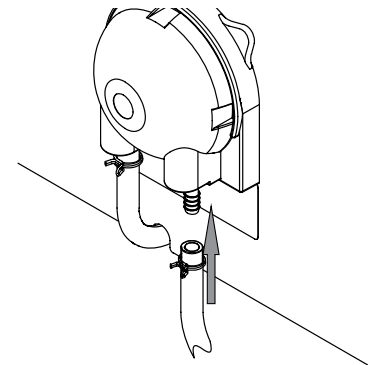

- ▶ Put the other end of the hose in a suitable collection device.

## 5.7 Installing the sample waste pump connection (MultiKjel T only)

- ▶ Attach the waste hose to the connection marked **Pump Sample Tube OUT**.
- ▶ Secure the hose in place with a hose clip.

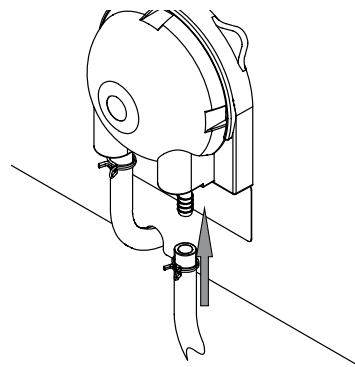

- ▶ Put the other end of the hose in a suitable collection device.

## 5.8 Installing the H<sub>2</sub>O supply for steam generation



### NOTE

MultiKjel only

The water supply comes from one canister.

Precondition:

- The water complies with the specified parameters. See Chapter 3.5 "Technical data", page 24
- Make sure that the instrument is not connected to the power supply.

- ▶ Install the inlet hose to the connection marked **H<sub>2</sub>O Steam Gen. IN**.
- ▶ Attach the inlet hose in place with a hose clip.

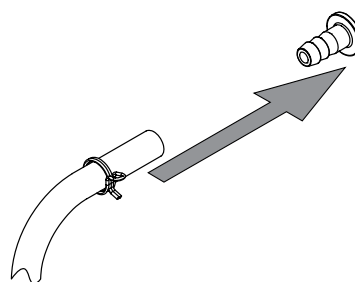

- ▶ Moist the aspiration hose.
- ▶ Push the hoses together.

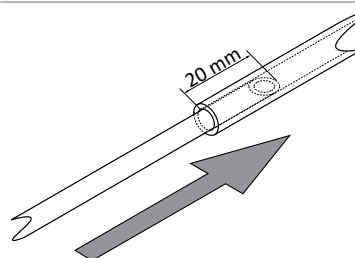

- ▶ Attach the hose grommet to the canister lid.

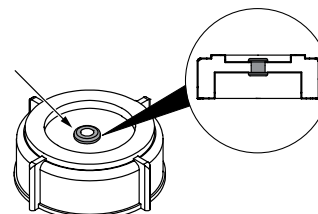



- ▶ Moist the hose.
- ▶ Insert the inlet hose through the opening of the cap nut and the screw cap of the water tank.
- ▶ Submerge the inlet hose into the water.

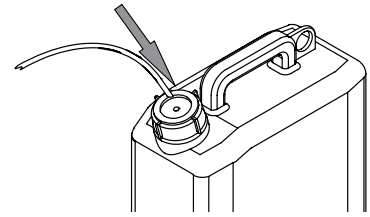

## 5.9 Installing NaOH supply (MultiKjel, MultiKjel T only)

- ▶ Install the inlet hose onto the connection marked **NaOH Sample Tube IN.**
- ▶ Attach the inlet hose in place with a hose clip.

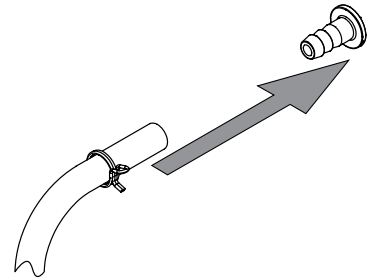

- ▶ Moist the aspiration hose.
- ▶ Push the hoses together.

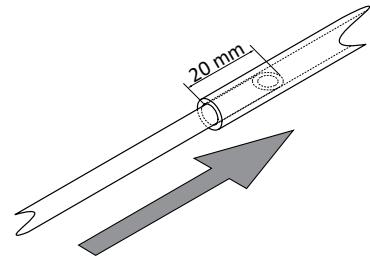

- ▶ Attach the hose grommet to the canister lid.

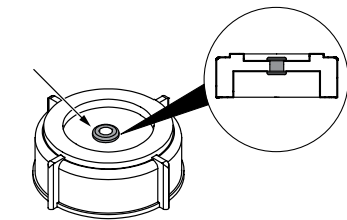

- ▶ Submerge the inlet hose into the NaOH.

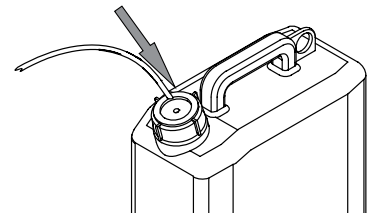

## 5.10 Installing H<sub>3</sub>BO<sub>3</sub> supply (MultiKjel, MultiKjel T only)

- ▶ Install the inlet hose to the connection marked **H<sub>3</sub>BO<sub>3</sub> Receiving Vessel IN.**
- ▶ Attach the inlet hose in place with a hose clip.

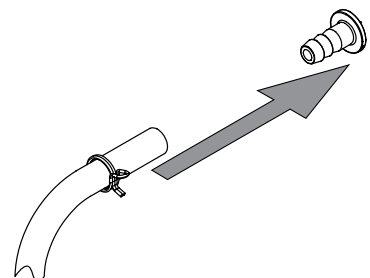

- ▶ Moist the aspiration hose.
- ▶ Push the hoses together.

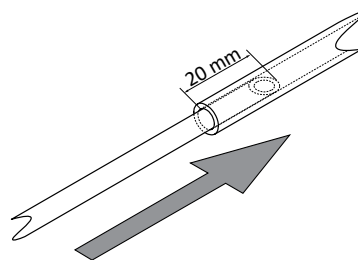

- ▶ Attach the hose grommet to the canister lid.

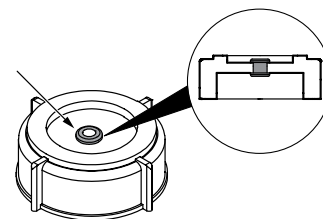

- ▶ Submerge the inlet hose into the H<sub>3</sub>BO<sub>3</sub>.

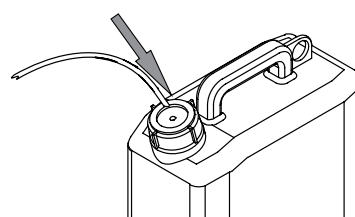

### 5.11 Installing the H<sub>2</sub>O supply for the sample tube (MultiKjel, MultiKjel T only)



#### NOTE

MultiKjel only

The water supply comes from one canister.

- ▶ Install the inlet hose to the connection marked **H<sub>2</sub>O Sample Tube IN.**
- ▶ Attach the inlet hose in place with a hose clip.

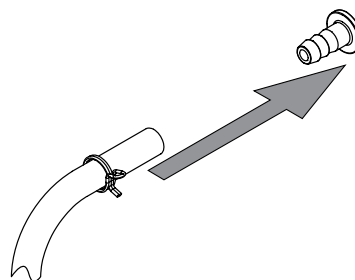

- ▶ Moist the aspiration hose.
- ▶ Push the hoses together.

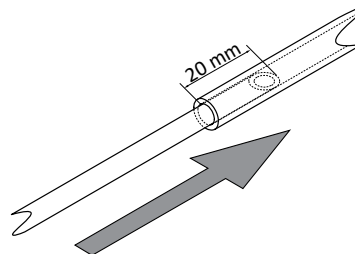

- ▶ Attach the hose grommet to the canister lid.

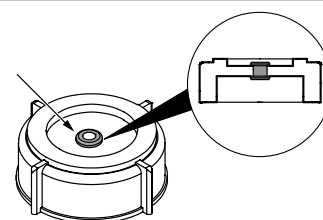

- ▶ Submerge the inlet hose into the H<sub>2</sub>O.

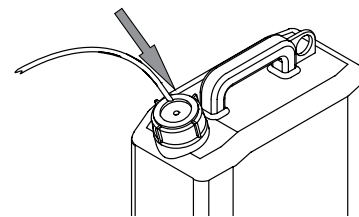

## 5.12 Installing the level sensor on the canister (option)



### NOTE

Do not expose the tank level sensor to an electromagnetic field in the frequency range of 2 to 10 MHz.

- ▶ Attach the hook-and-loop fastener sticker to the sensor.

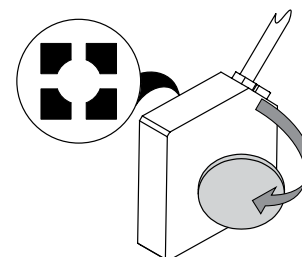

- ▶ Attach the strap to the canister.

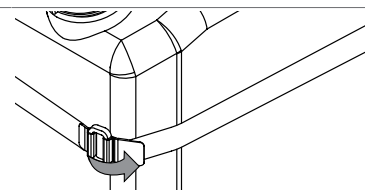

- ▶ Fix the sensor on the canister.

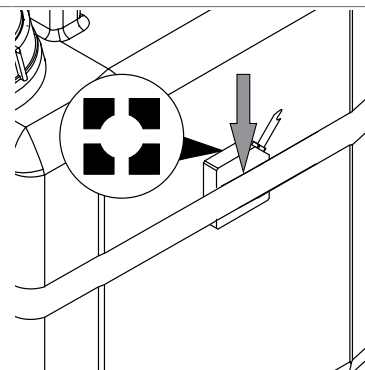

- ▶ Connect the sensor cable to the related connection on the instrument. See Chapter 3.2 "Configuration", page 14

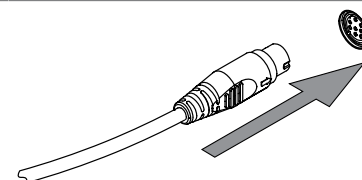

## 5.13 Installing a titrator with LAN (MultiKjel T with Eco Titrator only)

### Settings



### NOTE

Make sure, that the IP on both instruments is 192.168.10.3

- ▶ Connect the LAN cable to the related connection on the instrument. See Chapter 3.2 "Configuration", page 14

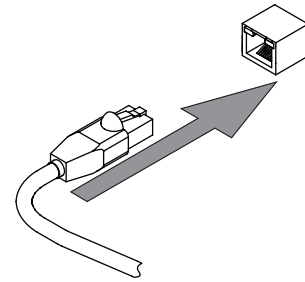

Specifications on the display:	
Precondition:	
<input checked="" type="checkbox"/> The titrator is prepared. See related manual	↓
▶ Navigate to the specified submenu.	Peripherals >
	↓
	Titrator Model >
▶ Select the specified action.	Titrator Model ...
▶ Tap the specified function on the function bar.	<b>EDIT</b>
▶ Select the titrator model you wish to use.	
▶ Tap the specified function on the function bar.	<b>SAVE</b>
⇒ The titrator model is saved.	

### 5.14 Installing a titrator with RS232 (MultiKjel only)

- Precondition:
- The dosing unit is prepared. See related documentation
  - ▶ Attach the plug onto the connection marked **Titrator (RS-232)**.
  - ▶ Secure the plug in place.

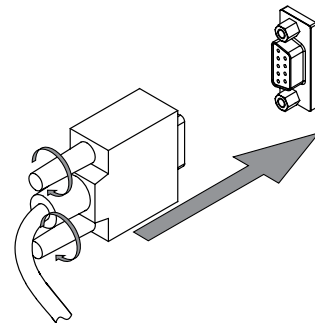

Specifications on the display:	
Precondition:	
<input checked="" type="checkbox"/> The titrator is prepared. See related manual	↓
<input checked="" type="checkbox"/> The instrument is connected to the LAN network.	↓
▶ Navigate to the specified submenu.	Peripherals >
	↓
	Titrator Model >
▶ Select the specified action.	Titrator Model ...
▶ Tap the specified function on the function bar.	<b>EDIT</b>

**Specifications on the display:**

- ▶ Select the titrator model you wish to use.

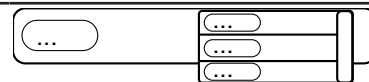

- ▶ Tap the specified function on the function bar.

**SAVE**

⇒ The titrator model is saved.

### 5.15 Installing a dispenser (MultiKjel T only)

Precondition:

- The dosing unit is prepared. See related Documentation
- ▶ Attach the plug onto the connection marked **Dosing Unit**.
- ▶ Secure the plug in place.

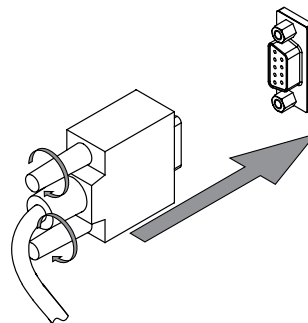

### 5.16 Installing the reaction detection sensor (MultiKjel T only)

- ▶ Attach the reaction detection sensor to the instrument.

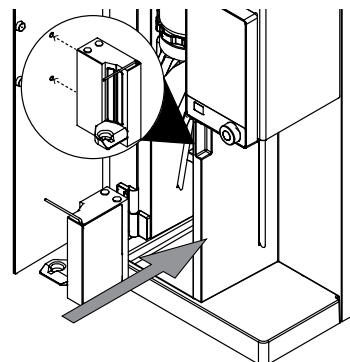

- ▶ Connect the sensor cable to the related connection on the instrument. See Chapter 3.2 "Configuration", page 14

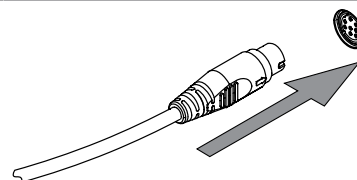

### 5.17 Installing a SD card (Interface pro only)

- ▶ Insert the SD card.
  - ▶ Restart the instrument.
- ⇒ The status bar shows the SD card symbol.

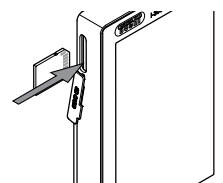

### 5.18 Installing the level detection sensor (option)



**NOTE**

Using the level detection sensor. See Chapter 8.11 "Preparing the level detection sensor (option)", page 74

- ▶ Attach the metal plate to the magnetic area of the instrument.

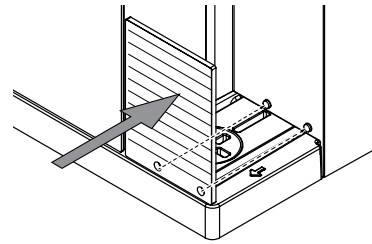

- ▶ Push the cable through the rear cable duct.

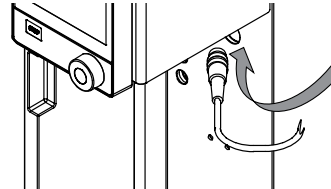

- ▶ Connect the sensor cable to the related connection on the instrument. See Chapter 3.2 "Configuration", page 14

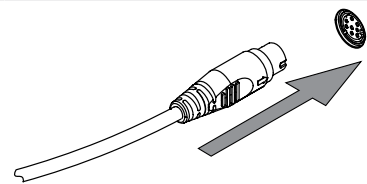

## 5.19 Installing the stirrer (MultiKjel only)

- ▶ Attach the stirrer to the receiving vessel.

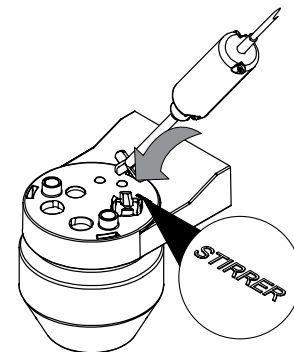

- ▶ Push the cable through the rear cable duct.

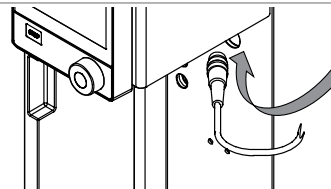

- ▶ Connect the sensor cable to the related connection on the instrument. See Chapter 3.2 "Configuration", page 14

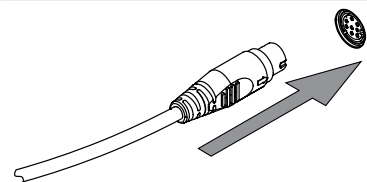

## 6 Description of the interface

### 6.1 Layout of the interface

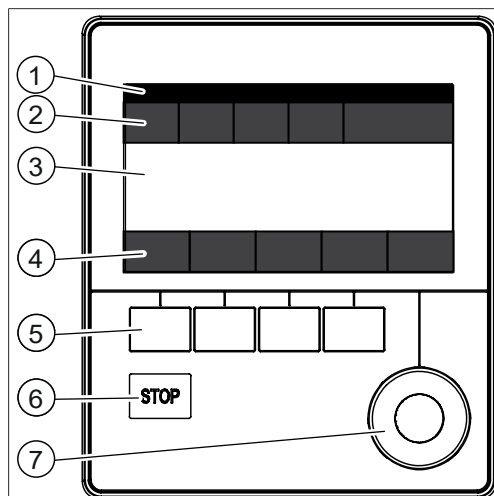
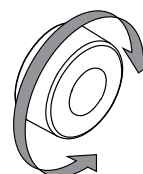

Fig. 16: Interface

No.	Description	Function
1	Status bar	Shows the determination name and status of the instrument. See Chapter 6.4 "Status bar interface", page 43
2	Menu bar	Shows symbols representing the menus. See Chapter 6.3 "Menu bar interface", page 40
3	Content area	Shows current settings, submenus or actions depending on the current operation.
4	Function bar	Shows functions that can be performed according to the current operation. See Chapter 6.2 "Function bar interface", page 40
5	Function buttons	Pressing a function button performs the assigned function on the function bar.
6	Stop button	
7	Navigation control	Used for navigating the user interface.

#### Using the navigation control

- Select an entry.





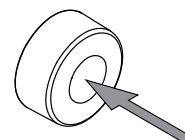





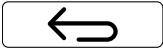

- Confirm the selected entry.





## 6.2 Function bar interface



The function bar shows available functions according to the current operation. The functions on the function bar are executed by tapping the relevant function buttons.

Symbol	Description	Meaning
	[Back]	The display reverts to the previous view.
	[Confirm]	Confirms an entry.
	[Start]	Starts an extraction process.
	[Copy]	Copies the selected method.
	[Edit]	Allows the selected item to be edited.
	[Ready]	Steam generator is ready to distill.
	[Preparation]	Carries out the method selected in the [Priming] submenu. See Chapter 8.2 "Editing the priming function", page 52
	[Template]	Saves the selected series as a template. Creates a series from the selected template.
	[Delete]	Deletes the selected entry.
	[Delete all]	Deletes all entries.
	[Standby]	The steam generator changes to standby mode.

## 6.3 Menu bar interface

Menu symbol	Name	Explanation
	Home menu	<ul style="list-style-type: none"> <li>• Process control parameters</li> </ul>
	Manual control menu	<ul style="list-style-type: none"> <li>• Start various processes manually</li> </ul>
	Process menu	<ul style="list-style-type: none"> <li>• Editing and saving:             <ul style="list-style-type: none"> <li>◦ Methods</li> <li>◦ Series</li> <li>◦ Templates</li> <li>◦ Determinations</li> </ul> </li> </ul>



Menu symbol	Name	Explanation
	<i>Configuration</i> menu	<ul style="list-style-type: none"> <li>• Change settings</li> <li>• Service menu</li> <li>• System information</li> </ul>
	<i>Determination</i> <i>data</i> menu	<ul style="list-style-type: none"> <li>• View processed determinations</li> </ul>

### 6.3.1 Home menu

### 6.3.2 Manual control menu

The manual control menu contains the following submenus:

Submenu	Explanation
Dose manually	See Chapter 8.13 "Dosing manually", page 74
Aspirate manually	See Chapter 8.14 "Aspirating manually", page 75
[Preheating]	See Chapter 8.1 "Editing the preheating function", page 52
[Priming]	See Chapter 8.2 "Editing the priming function", page 52
[Cleaning]	See Chapter 10.3 "Cleaning the glass components", page 83
[Stirring]	See Chapter 8.15 "Changing the stirring speed manually", page 76
[Pump Calibration]	See Chapter 10.14 "Calibrating the pumps", page 85

### 6.3.3 Method menu

The method menu contains the following submenus:

Submenu	Explanation
[Single Determination]	See Chapter 8.3 "Editing the single determination", page 52
[Series]	See Chapter 8.4 "Editing a series", page 55
[Templates]	See Chapter 8.5 "Editing a template", page 59
[Methods]	See Chapter 8.6 "Editing a method", page 60

### 6.3.4 Configuration menu

#### Settings submenu

Action	Option	Explanation
[Language]	Choice of display language on the interface	The following languages are available: English/German/French/Italian/Spanish/Japanese/Chinese/Russian/Polish
[Current Date]	Date input	Enter in sequence: Day, month, year. Apply the settings by pressing [Save].

<b>Action</b>	<b>Option</b>	<b>Explanation</b>
<i>[Current Time]</i>	Time input	Enter in sequence: Minutes, hours. Apply the settings by pressing <i>[Save]</i> .
Time zone	Choice of time zone	Select your time zone
<i>[Keyboard Layout]</i>	Choice of display keyboard on the interface	Select the keyboard layout
<i>[Key Tones]</i>	Off/On	Setting for audible signal in response to input controls.
<i>[Beep on Finish]</i>	Off/On	Setting for audible signal by the end of a determination.
<i>[Beep on Error]</i>	Off/On	Setting for audible signal by the end of a determination.
<i>[Display Brightness]</i>	Enter setting	Display illumination level in %: 0 - 100
<i>[Zero Amount Warning]</i>	On/Off	The instrument gives a warning when the entry for the weight is zero.
<i>[Default Amount Unit]</i>	Select value	The following values are selectable: g, mL
<i>[MaxAccuracy Mode]</i>	On / Off	Compensation of the steam power caused by voltage fluctuations.
<i>[AutoDist Mode]</i>	On/Off	Conditioning and distillation are performed automatically.
<i>[Level Detect. Max. Time]</i>	Enter value	The time after which the distillation stops without level detection sensor triggering.
<i>[Pump Maintenance Interval]</i>	Select value	Selecting a frequency to carry out a pump rinsing. See Chapter 10.20 "Rinsing a pump", page 90
<i>[H<sub>2</sub>O Dosage per Keypress]</i>	Enter value	Dosage volume which is applied by pressing the related button.
<i>[Acid Dosage per Keypress]</i>	Enter value	Dosage volume which is applied by pressing the related button.
<i>[NaOH Dosage per Keypress]</i>	Enter value	Dosage volume which is applied by pressing the related button.
<i>[Aspiration Time Receiver]</i>	Select value	Aspiration time for the related button.
<i>[Aspiration Time Sample Tube]</i>	Select value	Aspiration time for the related button.
<i>[H<sub>3</sub>BO<sub>3</sub> Dosage per Keypress]</i>	Enter value	Dosage volume which is applied by pressing the related button.
<i>[Steam Generator Standby]</i>	Enter value	Enter the time until the instrument turns automatically into standby.

Action	Option	Explanation
[Demo Mode]	On/Off	Simulate a distillation.
[Service Data Logger]	On/Off	Saves all data on the instrument for 14 months.

### Peripherals submenu

Shows information about the connected peripherals.

### Users submenu

Creating and setting users. See Chapter 8.7 "Editing user setting", page 71

### Network submenu

Action	Option	Explanation
[Network]	Enter value	The following parameters can be edited: Device name/MAC address/DHCP/ System IP address/Subnet mask/ Gateway/DNS server/BUCHI Cloud/ Server IP address

### Service submenu



#### NOTE

Only super user can carry out changes in the [Service] submenu.

### System Information submenu

Technical information about the connected devices (e.g. serial number, firmware version).







## 6.3.5 Determination data menu

Shows the history of the determination data.

## 6.4 Status bar interface

The status bar shows actual information about the instrument.

View	Status
	The instrument is in standby mode.
	Process is running.
	The instrument is heating up.
	The BLE dongle is connected to the instrument.
	A level detection sensor is connected to the instrument.
	Reaction detection sensor attached.

View	Status
	A tank level sensor is connected to the instrument.
	Dosing unit attached.
	Titration unit attached.
	White: A SD card is in the instrument. Red: The SD card in the instrument is in read only mode.
	A USB input device is connected.
	A USB memory stick is connected to the instrument.
	A recirculating chiller is connected.

## 7 Description of the interface pro



### CAUTION

#### Risk of injury from glass splinters

Sharp objects can damage the display.

- ▶ Keep sharp objects away from the display.

### 7.1 Layout of the interface pro

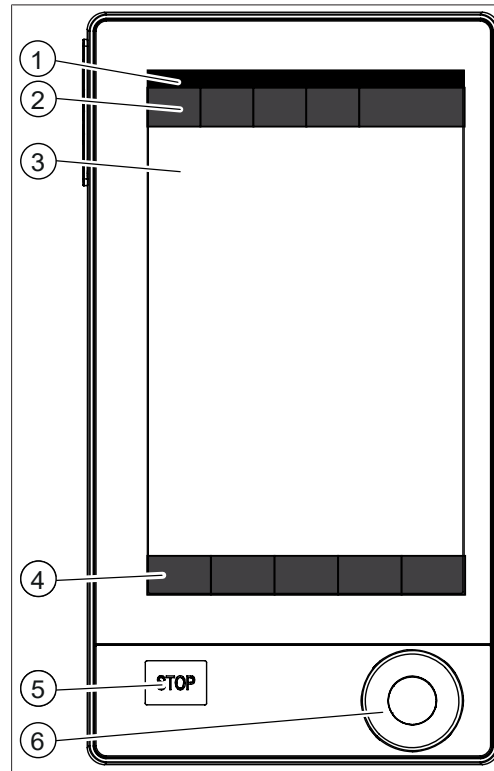
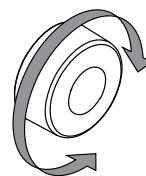

Fig. 17: Interface pro

No.	Description	Function
1	Status bar	Shows the determination name and status of the instrument. See Chapter 7.4 "Status bar interface pro", page 50
2	Menu bar	Shows symbols representing the menus.
3	Content area	Shows current settings, submenus or actions depending on the current operation.
4	Function bar	Shows functions that can be performed according to the current operation.
5	Stop button	
6	Navigation control	Used for navigating the user interface.

## Using the navigation control

- ▶ Select an entry.





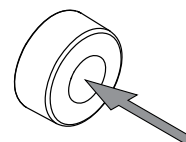





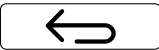

- ▶ Confirm the selected entry.







## 7.2 Function bar interface pro

The function bar shows available functions according to the current operation. The functions on the function bar are executed by tapping the relevant function buttons.

Symbol	Description	Meaning
	[Back]	The display reverts to the previous view.
	[Confirm]	Confirms an entry.
	[Start]	Starts an extraction process.
	[Copy]	Copies the selected method.
	[Edit]	Allows the selected item to be edited.
	[Ready]	Steam generator is ready to distill.
	[Preparation]	Carries out the method selected in the [Priming] submenu. See Chapter 8.2 "Editing the priming function", page 52
	[Template]	Saves the selected series as a template. Creates a series from the selected template.
	[Delete]	Deletes the selected entry.
	[Delete all]	Deletes all entries.
	[Standby]	The steam generator changes to standby mode.

## 7.3 Menu bar interface pro

Menu symbol	Name	Explanation
	<i>Home</i> menu	<ul style="list-style-type: none"> <li>• Process control parameters</li> </ul>
	<i>Manual control</i> menu	<ul style="list-style-type: none"> <li>• Start various processes manually</li> </ul>
	<i>Process</i> menu	<ul style="list-style-type: none"> <li>• Editing and saving:               <ul style="list-style-type: none"> <li>◦ Methods</li> <li>◦ Series</li> <li>◦ Templates</li> <li>◦ Determinations</li> </ul> </li> </ul>
	<i>Configuration</i> menu	<ul style="list-style-type: none"> <li>• Change settings</li> <li>• Service menu</li> <li>• System information</li> </ul>
	<i>Determination data</i> menu	<ul style="list-style-type: none"> <li>• View processed determinations</li> </ul>

### 7.3.1 Home menu

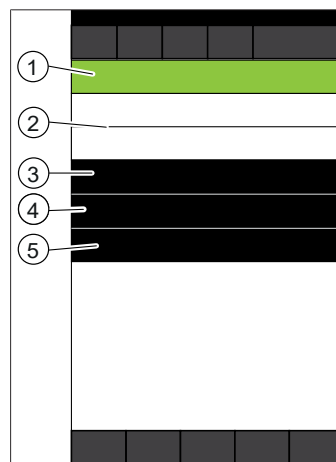

Fig. 18: Home menu during a determination

- |  |   |
|--|---|
| 1 Select and shows operation mode                              | 2 Preview of next determination                           |
| 3 Short-cut to determination data of the running determination | 4 Status of the determination (incl. corresponding icons) |
| 5 Remaining time   |   |

### 7.3.2 Manual control menu

The manual control menu contains the following submenus:

Submenu	Explanation
Dose manually	See Chapter 8.13 "Dosing manually", page 74
Aspirate manually	See Chapter 8.14 "Aspirating manually", page 75

Submenu	Explanation
[Preheating]	See Chapter 8.1 "Editing the preheating function", page 52
[Priming]	See Chapter 8.2 "Editing the priming function", page 52
[Cleaning]	See Chapter 10.3 "Cleaning the glass components", page 83
[Stirring]	See Chapter 8.15 "Changing the stirring speed manually", page 76
[Pump Calibration]	See Chapter 10.14 "Calibrating the pumps", page 85

### 7.3.3 Method menu

The method menu contains the following submenus:

Submenu	Explanation
[Single Determination]	See Chapter 8.3 "Editing the single determination", page 52
[Series]	See Chapter 8.4 "Editing a series", page 55
[Templates]	See Chapter 8.5 "Editing a template", page 59
[Methods]	See Chapter 8.6 "Editing a method", page 60

### 7.3.4 Configuration menu

#### Settings submenu

Action	Option	Explanation
[Language]	Choice of display language on the interface	The following languages are available: English/German/French/Italian/Spanish/Japanese/Chinese/Russian/Polish
[Current Date]	Date input	Enter in sequence: Day, month, year. Apply the settings by pressing [Save].
[Current Time]	Time input	Enter in sequence: Minutes, hours. Apply the settings by pressing [Save].
Time zone	Choice of time zone	Select your time zone
[Keyboard Layout]	Choice of display keyboard on the interface	Select the keyboard layout
[Key Tones]	Off/On	Setting for audible signal in response to input controls.
[Beep on Finish]	Off/On	Setting for audible signal by the end of a determination.
[Beep on Error]	Off/On	Setting for audible signal by the end of a determination.
[Display Brightness]	Enter setting	Display illumination level in %: 0 - 100
[Zero Amount Warning]	On/Off	The instrument gives a warning when the entry for the weight is zero.



<b>Action</b>	<b>Option</b>	<b>Explanation</b>
<i>[Default Amount Unit]</i>	Select value	The following values are selectable: g, mL
<i>[MaxAccuracy Mode]</i>	On / Off	Compensation of the steam power caused by voltage fluctuations.
<i>[AutoDist Mode]</i>	On/Off	Conditioning and distillation are performed automatically.
<i>[Level Detect. Max. Time]</i>	Enter value	The time after which the distillation stops without level detection sensor triggering.
<i>[Pump Maintenance Interval]</i>	Select value	Selecting a frequency to carry out a pump rinsing. See Chapter 10.20 "Rinsing a pump", page 90
<i>[H<sub>2</sub>O Dosage per Keypress]</i>	Enter value	Dosage volume which is applied by pressing the related button.
<i>[NaOH Dosage per Keypress]</i>	Enter value	Dosage volume which is applied by pressing the related button.
<i>[Acid Dosage per Keypress]</i>	Enter value	Dosage volume which is applied by pressing the related button.
<i>[H<sub>3</sub>BO<sub>3</sub> Dosage per Keypress]</i>	Enter value	Dosage volume which is applied by pressing the related button.
<i>[Aspiration Time Receiver]</i>	Select value	Aspiration time for the related button.
<i>[Aspiration Time Sample Tube]</i>	Select value	Aspiration time for the related button.
<i>[Steam Generator Standby]</i>	Enter value	Enter the time until the instrument turns automatically into standby.
<i>[Demo Mode]</i>	On/Off	Simulate a distillation.
<i>[Service Data Logger]</i>	On/Off	Saves all data on the instrument for 14 months.
<i>[Export Device]</i>	Select value	Select between the following data export devices: USB stick/SD card

### Peripherals submenu

Shows information about the connected peripherals.

### User administration submenu

Creating and setting users. See Chapter 8.7 "Editing user setting", page 71

### Network submenu

Action	Option	Explanation
[Network]	Enter value	The following parameters can be edited: Device name/DHCP/MAC address/ System IP address/Subnet mask/ Gateway

### Service submenu



#### NOTE

Only super user can carry out changes in the [Service] submenu.

### System Information submenu

Technical information about the connected devices (e.g. serial number, firmware version).

## 7.3.5 Determination data menu

Shows the history of the determination data.

## 7.4 Status bar interface pro

The status bar shows actual information about the instrument.

View	Status
	The instrument is in standby mode.
	Process is running.
	The instrument is heating up.
	The BLE dongle is connected to the instrument.
	A level detection sensor is connected to the instrument.
	Reaction detection sensor attached.
	A tank level sensor is connected to the instrument.
	Dosing unit attached.
	Titration unit attached.
	White: A SD card is in the instrument. Red: The SD card in the instrument is in read only mode.
	A USB input device is connected.
	A USB memory stick is connected to the instrument.

---







View	Status
	A recirculating chiller is connected.

---

## 8 Preparations for a determination

### 8.1 Editing the preheating function

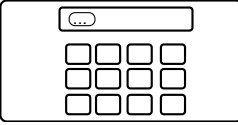
The preheating function defines how long the instrument parts are conditioned with steam.

	<b>Specifications on the display:</b>
▶ Navigate to the specified submenu.	 ↓
	
▶ Select the preheating function for which you want to change the preheating time.	
▶ Tap the specified function on the function bar.	
▶ Enter the preheating time in seconds.	
▶ Tap the specified function on the function bar. ⇒ The time is saved.	

### 8.2 Editing the priming function



#### NOTE

The method selected in this submenu is used for preparation.

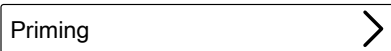
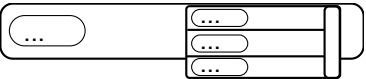
	<b>Specifications on the display:</b>
▶ Navigate to the specified submenu.	 ↓
	
▶ Select the method you wish to use. ⇒ The priming method is selected.	

### 8.3 Editing the single determination

#### 8.3.1 Changing the name of the single determination





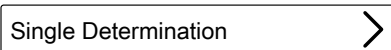

#### NOTE

The name of the single determination is displayed in the *[Determination data]* menu.

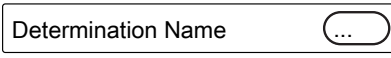
	<b>Specifications on the display:</b>
▶ Navigate to the specified submenu.	 ↓
	

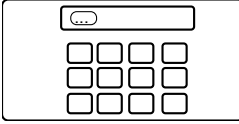
**Specifications on the display:**







▶ Select the specified action.	
▶ Tap the specified function on the function bar.	
▶ Enter the name for the single determination.	
▶ Tap the specified function on the function bar. ⇒ The name for the determination is saved.	

### 8.3.2 Selecting the determination type for a single determination

The following determination types are selectable:

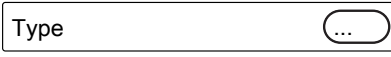

Determination type	Explanation
[Blank]	For determinations without sample.
[Reference Substance]	For determinations with a defined reference substance.
[Sample]	For determinations with unknown sample.

**Specifications on the display:**

▶ Navigate to the specified submenu.	 ↓ 
▶ Select the specified action.	
▶ Tap the specified function on the function bar.	
▶ Select the determination type you wish to use. ⇒ The determination type is selected.	
▶ Tap the specified function on the function bar.	

### 8.3.3 Selecting the method for a single determination

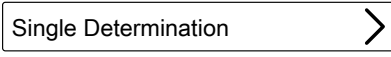
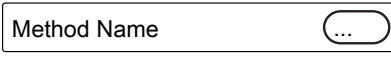
**Specifications on the display:**

▶ Navigate to the specified submenu.	 ↓ 
▶ Select the specified action.	
▶ Tap the specified function on the function bar.	
▶ Select the method you wish to use. ⇒ The method is selected.	

**Specifications on the display:**

▶ Tap the specified function on the function bar.

SAVE

### 8.3.4 Changing the sample quantity for single determination

**Specifications on the display:**

Precondition:

The determination type is set to *[Sample]*. See Chapter 8.3.2 "Selecting the determination type for a single determination", page 53



Single Determination



▶ Navigate to the specified submenu.

▶ Select the specified action.



▶ Tap the specified function on the function bar.

EDIT

▶ Enter a value for the sample weight.

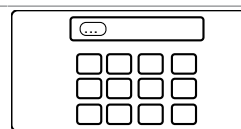

▶ Tap the specified function on the function bar.

SAVE

⇒ The sample weight is saved.

### 8.3.5 Changing the unit for a single determination

The following units are available:

Unit	Explanation
[g]	Enter the weight for the determination in gram.
[ml]	Enter the weight for the determination in mL.

**Specifications on the display:**

Precondition:

The determination type is set to *[Sample]* or *[Reference Substance]*. See Chapter 8.3.2 "Selecting the determination type for a single determination", page 53



Single Determination



▶ Navigate to the specified submenu.

▶ Select the specified action.



▶ Tap the specified function on the function bar.

EDIT

▶ Select the unit you wish to use.

⇒ The unit is saved.

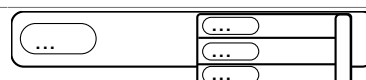

▶ Tap the specified function on the function bar.

SAVE

## 8.4 Editing a series

### 8.4.1 Creating a new series



There are two possibilities to create new series:

- Chapter "Creating a new series", page 55
- Chapter "Creating a new series from a template", page 55

#### Creating a new series

	Specifications on the display:
▶ Navigate to the specified submenu.	
	⋮
	<input style="width: 100%;" type="text" value="Series"/>
▶ Tap the specified function on the function bar. ⇒ The new series is created.	<input type="button" value="NEW"/>

#### Creating a new series from a template

	Specifications on the display:
▶ Navigate to the specified submenu.	
	⋮
	<input style="width: 100%;" type="text" value="Templates"/>
▶ Select the template from which you want to create a series.	<input style="width: 100%;" type="text" value="..."/>
▶ Tap the specified function on the function bar. ⇒ The series is created.	

### 8.4.2 Changing the name of a series

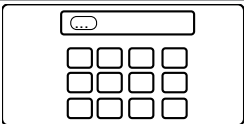
	Specifications on the display:
▶ Navigate to the specified submenu.	
	⋮
	<input style="width: 100%;" type="text" value="Series"/>
▶ Select the name of the series that you wish to edit.	<input style="width: 100%;" type="text" value="..."/>
▶ Select the specified action.	<input style="width: 100%;" type="text" value="Series Name"/>
▶ Tap the specified function on the function bar.	<input type="button" value="EDIT"/>
▶ Enter a name for the series.	
▶ Tap the specified function on the function bar. ⇒ The name is saved.	<input type="button" value="SAVE"/>

### 8.4.3 Adding a determination to a series

#### Add the first determination to a series

Specifications on the display:	
▶ Navigate to the specified submenu.	
	↓
	<input type="text" value="Series"/>
▶ Select the series you wish to edit.	<input type="text" value="..."/>
▶ Tap the specified function on the function bar. ⇒ The determination is created.	<input type="button" value="NEW"/>

#### Add more determinations to a series by copy existing

Specifications on the display:	
▶ Navigate to the specified submenu.	
	↓
	<input type="text" value="Series"/>
▶ Select the series you wish to edit.	<input type="text" value="..."/>
▶ Select the determination you wish to copy.	<input type="text" value="..."/>
▶ Tap the specified function on the function bar. ⇒ The determination is created.	<input type="button" value="COPY"/>



### 8.4.4 Deleting a determination from a series

Specifications on the display:	
▶ Navigate to the specified submenu.	
	↓
	<input type="text" value="Series"/>
▶ Select the series you wish to edit.	<input type="text" value="..."/>
▶ Select the determination you wish to delete.	<input type="text" value="..."/>
▶ Tap the specified function on the function bar. ⇒ The determination is deleted.	<input type="button" value="DELETE"/>

### 8.4.5 Changing the determination name for a series

Specifications on the display:	
▶ Navigate to the specified submenu.	
	↓
	<input type="text" value="Series"/>

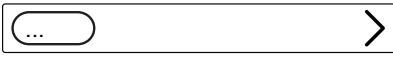

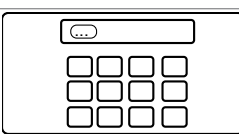



<b>Specifications on the display:</b>	
▶ Select the series you wish to edit.	
▶ Select the determination you wish to edit.	
▶ Select the specified action.	Determination Name 
▶ Tap the specified function on the function bar.	<b>EDIT</b>
▶ Enter the name for the single determination.	
▶ Tap the specified function on the function bar.	<b>SAVE</b>
⇒ The name for the determination is saved.	





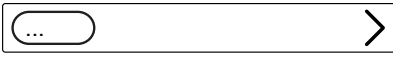

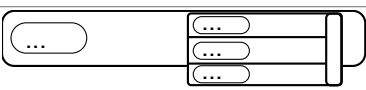

### 8.4.6 Selecting the determination type within a series

The following determination types are selectable:





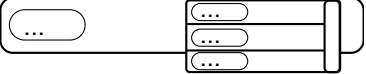



<b>Determination type</b>	<b>Explanation</b>
<i>[Blank]</i>	For determinations without sample.
<i>[Reference Substance]</i>	For determinations with a defined reference substance.
<i>[Sample]</i>	For determinations with unknown sample.

<b>Specifications on the display:</b>	
▶ Navigate to the specified submenu.	 ↓
	Series 
▶ Select the series you wish to edit.	
▶ Select the determination you wish to edit.	
▶ Select the specified action.	Type 
▶ Tap the specified function on the function bar.	<b>EDIT</b>
▶ Select the determination type you wish to use. ⇒ The determination type is selected.	
▶ Tap the specified function on the function bar.	<b>SAVE</b>
⇒ The name for the determination is saved.	

### 8.4.7 Selecting the method for a determination within a series

	Specifications on the display:
▶ Navigate to the specified submenu.	 ↓
	
▶ Select the series you wish to edit.	
▶ Select the determination you wish to edit.	
▶ Select the specified action.	
▶ Tap the specified function on the function bar.	
▶ Select the determination type you wish to use. ⇒ The determination type is selected.	
▶ Tap the specified function on the function bar.	

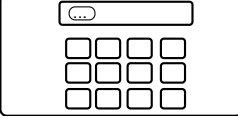
### 8.4.8 Changing the sample quantity for determination within a series







	Specifications on the display:
Precondition: <input checked="" type="checkbox"/> The determination type is set to <i>[Sample]</i> or <i>[Reference Substance]</i> . See Chapter 8.4.6 "Selecting the determination type within a series", page 57	
▶ Navigate to the specified submenu.	 ↓
	
▶ Select the series you wish to edit.	
▶ Select the determination you wish to edit.	
▶ Select the specified action.	
▶ Tap the specified function on the function bar.	
▶ Enter a value for the sample weight.	
▶ Tap the specified function on the function bar. ⇒ The value for the sample weight is saved.	

### 8.4.9 Changing the amount unit for a determination within a series

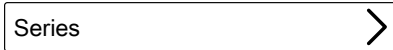
The following units are available:

Unit	Explanation
<i>[g]</i>	Enter the weight for the determination in gram. Chapter 8.3.4 "Changing the sample quantity for single determination", page 54

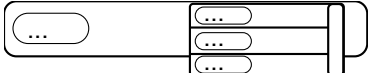
Unit	Explanation
[ml]	Enter the weight for the determination in mL. See Chapter 8.3.4 "Changing the sample quantity for single determination", page 54

	Specifications on the display:
Precondition:	
<input checked="" type="checkbox"/> The determination type is set to <i>[Sample]</i> or <i>[Reference Substance]</i> . See Chapter 8.4.6 "Selecting the determination type within a series", page 57	↓ 
▶ Navigate to the specified submenu.	
▶ Select the series you wish to edit.	
▶ Select the determination you wish to edit.	
▶ Select the specified action.	Unit 
▶ Tap the specified function on the function bar.	
▶ Select the determination type you wish to use. ⇒ The determination type is selected.	
▶ Tap the specified function on the function bar.	





## 8.5 Editing a template

### 8.5.1 Creating a new template



There are two possibilities to create a template:

- Chapter "Creating a new template", page 60
- Chapter "Creating a new template from an existing series", page 59







#### Creating a new template from an existing series

	Specifications on the display:
▶ Navigate to the specified submenu.	
	↓ 
▶ Select the series from which you want to create a template.	
▶ Tap the specified function on the function bar. ⇒ The template is created.	

### Creating a new template

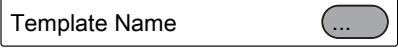

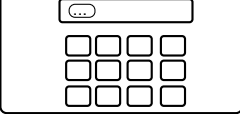

	Specifications on the display:
▶ Navigate to the specified submenu.	 ↓ 
▶ Tap the specified function on the function bar. ⇒ The template is created.	

### 8.5.2 Changing the name of a template

	Specifications on the display:
▶ Navigate to the specified submenu.	 ↓ 
▶ Select the name of the template that you wish to edit.	
▶ Select the specified action.	
▶ Tap the specified function on the function bar.	
▶ Enter a name for the template.	
▶ Tap the specified function on the function bar. ⇒ The template name is saved.	

## 8.6 Editing a method

### 8.6.1 Creating a new method

	Specifications on the display:
▶ Navigate to the specified submenu.	 ↓ 
▶ Select a method you wish to copy.	
▶ Tap the [Copy] function on the function bar. ⇒ A new method is created.	

### 8.6.2 Deleting a method



**NOTE**

Default methods [Priming Method] and [Standard Method] cannot be deleted.

**Specifications on the display:**

- ▶ Navigate to the specified submenu.



Methods >

- ▶ Select a method you wish to delete.



- ▶ Tap the specified function on the function bar.

DELETE

- ▶ Confirm the secure question.

⇒ The method is deleted.

### 8.6.3 Changing the name of a method

**Specifications on the display:**

- ▶ Navigate to the specified submenu.



Methods >

- ▶ Select the method that you wish to edit.



- ▶ Select the specified action.

Method Name ...

- ▶ Tap the specified function on the function bar.

EDIT

- ▶ Enter a name for the method.

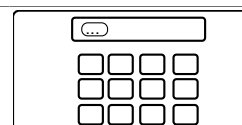

- ▶ Tap the specified function on the function bar.

SAVE

⇒ The name is saved.

### 8.6.4 Changing the reaction detection for a method (option for MultiKjel only)

The reaction detection sensor monitors the alkalization and doses the NaOH accordingly. The instrument switches automatically off when the alkalization is completed.

Status	Explanation
On	Automatic alkalization during the determination.
Off	Enter the parameters for the alkalization manually.

**Specifications on the display:**

- ▶ Navigate to the specified submenu.



Methods >

Specifications on the display:	
▶ Select the method that you wish to edit.	
▶ Select the specified action.	Reaction Detection
▶ Tap the specified function on the function bar.	<b>EDIT</b>
⇒ The status is changed.	

### 8.6.5 Changing the H<sub>2</sub>O volume for a method (MultiKjel only)



#### NOTE

The [*Reaction Detection*] action is set to Off. See Chapter 8.6.4 "Changing the reaction detection for a method (option for MultiKjel only)", page 61

Manually entering the quantity of H<sub>2</sub>O to dilute the sample.

The input values can be found in the corresponding "*Application note*".

Specifications on the display:	
▶ Navigate to the specified submenu.	
	↓
	Methods
▶ Select the method that you wish to edit.	
▶ Select the specified action.	H <sub>2</sub> O Volume
▶ Tap the specified function on the function bar.	<b>EDIT</b>
▶ Enter the volume quantity.	
▶ Tap the specified function on the function bar.	<b>SAVE</b>
⇒ The quantity for the dosing is saved.	

### 8.6.6 Changing the H<sub>2</sub>SO<sub>4</sub> volume for a method (MultiKjel only)







#### NOTE

The [*Reaction Detection*] action is set to On. See Chapter 8.6.4 "Changing the reaction detection for a method (option for MultiKjel only)", page 61

Enter manually the quantity of sulfuric acid.

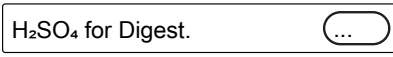
The value is known from the previous digestion process.

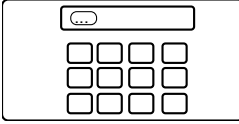
Specifications on the display:	
▶ Navigate to the specified submenu.	
	↓
	Methods
▶ Select the method that you wish to edit.	

<b>Specifications on the display:</b>	
▶ Select the specified action.	
▶ Tap the specified function on the function bar.	
▶ Enter the quantity of the sulfuric acid.	
▶ Tap the specified function on the function bar.	
⇒ The quantity for the sulfuric acid is saved.	

### 8.6.7 Changing the NaOH volume for a method (MultiKjel only)







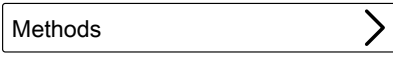

#### NOTE

The [*Reaction Detection*] action is set to Off. See Chapter 8.6.4 "Changing the reaction detection for a method (option for MultiKjel only)", page 61

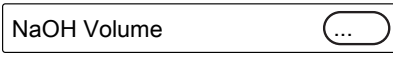

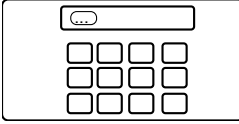
Enter manually the quantity of NaOH for alkalinizing the sample.

For the correct quantity check related "*Application note* " or use the KjelOptimizer App.

<b>Specifications on the display:</b>	
▶ Navigate to the specified submenu.	 ↓
	
▶ Select the method that you wish to edit.	
▶ Select the specified action.	
▶ Tap the specified function on the function bar.	
▶ Enter the quantity for the dosing.	
▶ Tap the specified function on the function bar.	
⇒ The quantity for the dosing is saved.	

### 8.6.8 Changing the acid volume for a method (BasicKjel, MultiKjel only)

Enter manually the quantity of reagent to be dosed.

<b>Specifications on the display:</b>	
▶ Navigate to the specified submenu.	 ↓
	
▶ Select the method that you wish to edit.	

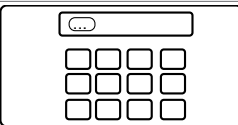



Specifications on the display:	
▶ Select the specified action.	Acid Volume 
▶ Tap the specified function on the function bar.	<b>EDIT</b>
▶ Enter the quantity for the dosing.	
▶ Tap the specified function on the function bar.	<b>SAVE</b>
⇒ The quantity for the dosing is saved.	

### 8.6.9 Changing the reaction time for a method (BasicKjel, MultiKjel only)



#### NOTE

The *[Reaction Detection]* action is set to Off. See Chapter 8.6.4 "Changing the reaction detection for a method (option for MultiKjel only)", page 61

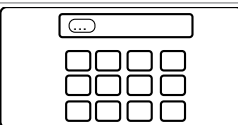
Specifications on the display:	
▶ Navigate to the specified submenu.	 ↓ Methods 
▶ Select the method that you wish to edit.	 
▶ Select the specified action.	Reaction Time 
▶ Tap the specified function on the function bar.	<b>EDIT</b>
▶ Enter a value for the reaction time.	
▶ Tap the specified function on the function bar.	<b>SAVE</b>
⇒ The reaction time is saved.	







### 8.6.10 Changing the number of steam steps for a method

Select steps to get the steam power gradually.

Selection	Explanation
[None]	Steam power in % selectable. See Chapter 8.6.12 "Changing the steam power for a method", page 66
[2]	Steam power in % selectable. See Chapter 8.6.12 "Changing the steam power for a method", page 66 Duration time of the steam step selectable. See Chapter 8.6.11 "Changing the time a steam step is carried out for a method", page 65

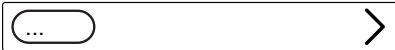

Selection	Explanation
[3]	Steam power in % selectable. See Chapter 8.6.12 "Changing the steam power for a method", page 66 and Duration time of the steam step selectable. See Chapter 8.6.11 "Changing the time a steam step is carried out for a method", page 65

	Specifications on the display:
▶ Navigate to the specified submenu.	 ↓ 
▶ Select the method that you wish to edit.	
▶ Select the specified action.	
▶ Tap the specified function on the function bar.	
▶ Select the number of steps you wish to use.	
▶ Tap the specified function on the function bar.	



### 8.6.11 Changing the time a steam step is carried out for a method





**NOTE**

Calculating the starting time for a steam step

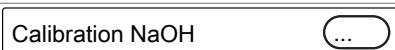

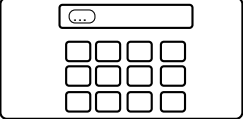



- ☑ Make sure that the distillation time is set longer than the calculated time for the steam steps. See Chapter 8.6.14 "Changing the distillation time for a method", page 67
- ▶ Starting time for steam step two:
  - ⇒ The duration time of the first steam step.
- ▶ Starting time for steam step three:
  - ⇒ The duration time of the first steam step.
  - ⇒ +
  - ⇒ The duration time of the second steam step.

	Specifications on the display:
Precondition:	 ↓
☑ More than one steam step is selected. See Chapter 8.6.10 "Changing the number of steam steps for a method", page 64	
▶ Navigate to the specified submenu.	
▶ Select the method that you wish to edit.	
▶ Select the specified action.	

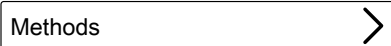
<b>Specifications on the display:</b>	
▶ Tap the specified function on the function bar.	
▶ Enter the time for the steam step.	
▶ Tap the specified function on the function bar. ⇒ The time for the steam step is saved.	

### 8.6.12 Changing the steam power for a method

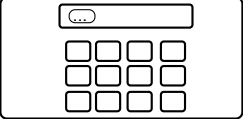
The steam power in % during a steam step.

<b>Specifications on the display:</b>	
▶ Navigate to the specified submenu.	 ↓
	
▶ Select the method that you wish to edit.	
▶ Select the specified action.	
▶ Tap the specified function on the function bar.	
▶ Enter the level for the steam power.	
▶ Tap the specified function on the function bar. ⇒ The level for the steam power is saved.	

### 8.6.13 Changing the level detection sensor settings (option) for a method



The level detection stops the distillation when a defined distillate volume is reached.



#### NOTE

The maximum level detection time can be changed in the *Settings* submenu.

Selection	Explanation
On	The level detection sensor is active.
Off	The level detection sensor is off.

<b>Specifications on the display:</b>	
▶ Navigate to the specified submenu.	 ↓
	
▶ Select the method that you wish to edit.	

**Specifications on the display:**

- ▶ Select the specified action. Level Detection

---

- ▶ Tap the specified function on the function bar. EDIT
- ⇒ The status changed.

### 8.6.14 Changing the distillation time for a method

Enter manually the time for the determination.

**Specifications on the display:**

- Precondition:
- The [*Level Detection*] action is set to Off. See Chapter 8.6.13 "Changing the level detection sensor settings (option) for a method", page 66
- ▶ Navigate to the specified submenu.  ↓  
Methods >

---

  - ▶ Select the method that you wish to edit. ... >

---

  - ▶ Select the specified action. Distillation Time ...

---

  - ▶ Tap the specified function on the function bar. EDIT

---

  - ▶ Enter a value for the distillation time.   

---

  - ▶ Tap the specified function on the function bar. SAVE
  - ⇒ The distillation time is saved.

### 8.6.15 Changing the distillation stirring speed for a method (MultiKjel T only)

**Specifications on the display:**

- ▶ Navigate to the specified submenu.  ↓  
Methods >

---

- ▶ Select the method that you wish to edit. ... >

---

- ▶ Select the specified action. Stirrer Speed Dist. ...

---

- ▶ Tap the specified function on the function bar. EDIT

---







- ▶ Enter the stirring speed.   

---

- ▶ Tap the specified function on the function bar. SAVE
- ⇒ The stirring speed is saved.

### 8.6.16 Changing the titration type for a method (MultiKjel T only)

Titration type	Explanation
[None]	No titration
[Boric Acid Titration]	Titration
[Back Titration]	Back titration







	Specifications on the display:
▶ Navigate to the specified submenu.	 ↓
	
▶ Select the method that you wish to edit.	
▶ Select the specified action.	
▶ Tap the specified function on the function bar.	
▶ Select the titration type you wish to use.	
▶ Tap the specified function on the function bar.	

### 8.6.17 Changing the H<sub>3</sub>BO<sub>3</sub> volume for a method (MultiKjel only)

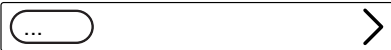

#### NOTE

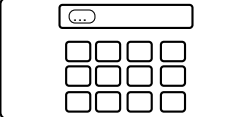
The availability depends on the selected titration type.



	Specifications on the display:
▶ Navigate to the specified submenu.	 ↓
	
▶ Select the method that you wish to edit.	
▶ Select the specified action.	
▶ Tap the specified function on the function bar.	
▶ Enter the quantity for the volume.	
▶ Tap the specified function on the function bar.	
⇒ The volume is saved.	

### 8.6.18 Changing the dosing unit volume for a method (MultiKjel T only)



#### NOTE

The availability depends on the selected titration type.

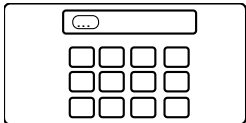

	Specifications on the display:
▶ Navigate to the specified submenu.	 ↓ Methods >
▶ Select the method that you wish to edit.	 >
▶ Select the specified action.	Dosing Unit Vol. 
▶ Tap the specified function on the function bar.	<b>EDIT</b>
▶ Enter the quantity for the volume.	
▶ Tap the specified function on the function bar.	<b>SAVE</b>
⇒ The volume is saved.	

### 8.6.19 Changing the titration stirring speed for a method (MultiKjel T only)



#### NOTE

The availability depends on the selected titration type.

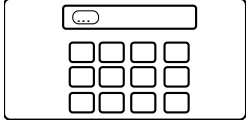





	Specifications on the display:
Precondition:	 ↓
<input checked="" type="checkbox"/> A titration type is activated. See	
▶ Navigate to the specified submenu.	Methods >
▶ Select the method that you wish to edit.	 >
▶ Select the specified action.	Stirrer Speed Titr. 
▶ Tap the specified function on the function bar.	<b>EDIT</b>
▶ Enter the stirring speed.	
▶ Tap the specified function on the function bar.	<b>SAVE</b>
⇒ The stirring speed is saved.	

### 8.6.20 Changing the titration start time for a method (MultiKjel T only)



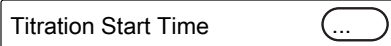

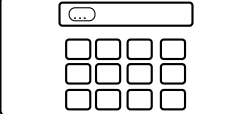



#### NOTE



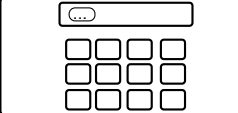

The availability depends on the selected titration type.

<b>Specifications on the display:</b>	
▶ Navigate to the specified submenu.	 ↓
	
▶ Select the method that you wish to edit.	
▶ Select the specified action.	
▶ Tap the specified function on the function bar.	
▶ Enter a value for the titration start time.	
▶ Tap the specified function on the function bar.	
⇒ The start time is saved.	

### 8.6.21 Changing the aspiration time for the sample tube for a method (BasicKjel, MultiKjel, MultiKjel T only)

<b>Specifications on the display:</b>	
▶ Navigate to the specified submenu.	 ↓
	
▶ Select the method that you wish to edit.	
▶ Select the specified action.	
▶ Tap the specified function on the function bar.	
▶ Enter a value for the aspiration time.	
▶ Tap the specified function on the function bar.	
⇒ The aspiration time is saved.	

### 8.6.22 Changing the aspiration time for the receiving vessel for a method (MultiKjel T only)

<b>Specifications on the display:</b>	
▶ Navigate to the specified submenu.	 ↓
	
▶ Select the method that you wish to edit.	
▶ Select the specified action.	

**Specifications on the display:**

- ▶ Tap the specified function on the function bar. **EDIT**

---

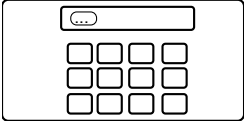
- ▶ Enter a value for the aspiration time. 

---

- ▶ Tap the specified function on the function bar. **SAVE**  
⇒ The aspiration time is saved.

## 8.7 Editing user setting



**NOTE**

The user [Service User] is a default user and password protected.

### 8.7.1 Creating a new user

**Specifications on the display:**

- ▶ Navigate to the specified submenu.   
↓  
User Administration >

---

- ▶ Tap the specified function on the function bar. **NEW**

---

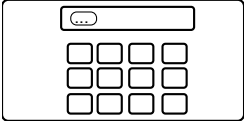
- ▶ Enter a name for the user. 

---

- ▶ Tap the specified function on the function bar. **SAVE**

### 8.7.2 Deleting a user

**Specifications on the display:**

- ▶ Navigate to the specified submenu.   
↓  
User Administration >

---

- ▶ Select the user you wish to delete. ... ...







---

- ▶ Tap the specified function on the function bar. **DELETE**



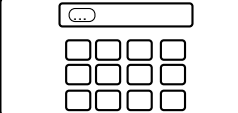

---

- ▶ Confirm the secure question.  
⇒ The user is deleted.

### 8.7.3 Changing the name of a user

Specifications on the display:	
▶ Navigate to the specified submenu.	 ↓
	
▶ Select the user that you wish to edit.	
▶ Tap the specified function on the function bar.	
▶ Enter a new name for the user.	
▶ Tap the specified function on the function bar. ⇒ The new name is saved.	

### 8.7.4 Selecting a user

Specifications on the display:	
▶ Navigate to the specified submenu.	 ↓
	
▶ Select the user you wish to use.	
▶ Tap the specified function on the function bar. ⇒ The user is active. ⇒ The user is marked up green.	

## 8.8 Installing the sample tube



#### NOTE

Removing is done in reverse sequence.

Precondition:

- ☑ Make sure, that the end stop is in the correct position for the sample tube in use. See Chapter 8.10 "Preparing the end stop for the sample tube size", page 73

- ▶ Hold the sample tube with the tongs.

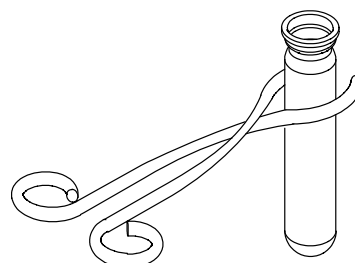



- ▶ Insert the sample tube.

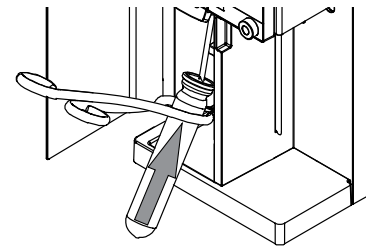

- ▶ Apply a light force to push the sample tube against the end stop and the sample tube sealing.

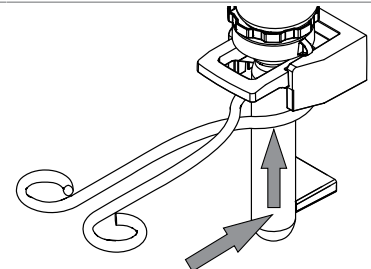

- ▶ Secure the sample tube in place with the handle.

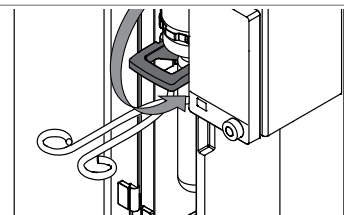

## 8.9 Installing a receiving vessel

- ▶ Insert the sample receiving vessel to the instrument.

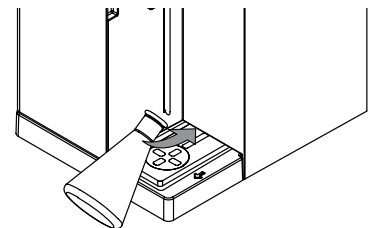

- ▶ Place the sample receiving vessel on the receiving vessel area.

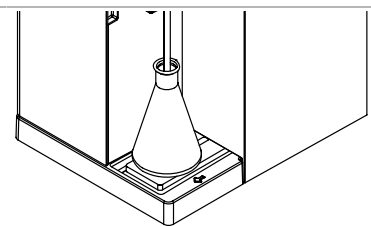

## 8.10 Preparing the end stop for the sample tube size

- ▶ Pull the end stop.
- ▶ Twist the end stop.

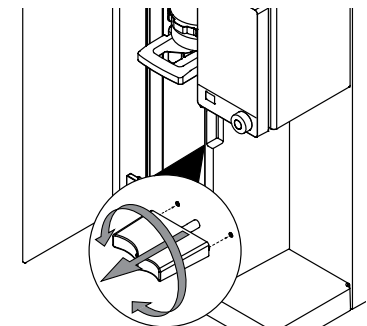

## 8.11 Preparing the level detection sensor (option)

Precondition:

- ☑ The installations for the level sensor are completed. See Chapter 5.18 "Installing the level detection sensor (option)", page 37
- ▶ Attach the magnetic level sensor to the metal plate.

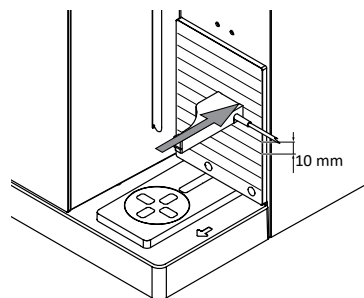

- ▶ Adjust the sensor near the sample receiving vessel.

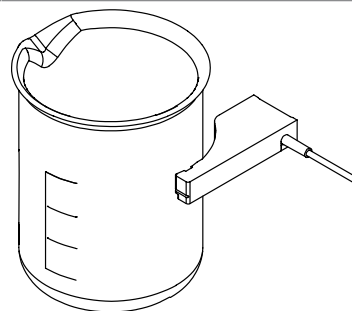





## 8.12 Selecting the operation mode

Select one of the following operation modes:

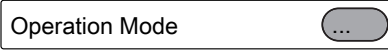
Operation mode	Explanation
[Single Determination]	For carrying out one determination. Editing settings see Chapter 8.3 "Editing the single determination", page 52
[Series]	For planning and carrying out a series of determinations. Editing settings see Chapter 8.4 "Editing a series", page 55

### Specifications on the display:

▶ Navigate to the specified menu.	
▶ Select the specified action.	
▶ Tap the specified function on the function bar.	
▶ Select the operation mode according to your requirements.	
▶ Tap the specified function on the function bar.	

## 8.13 Dosing manually

### 8.13.1 Dosing H<sub>2</sub>O manually



#### NOTE

The quantity of liquid per keystroke can be changed in the [Settings] submenu.

**Specifications on the display:**

Precondition:



- A sample tube is installed. See Chapter 8.8 "Installing the sample tube", page 72

- ▶ Navigate to the specified menu.

- ▶ Tap the specified button.

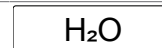

- ⇒ The pump applies a defined quantity of H<sub>2</sub>O.

**8.13.2 Dosing NaOH manually****NOTE**

The quantity of liquid per keystroke can be changed in the *[Settings]* submenu.

**Specifications on the display:**

Precondition:



- A sample tube is installed. See Chapter 8.8 "Installing the sample tube", page 72

- ▶ Navigate to the specified menu.

- ▶ Tap the specified button.



- ⇒ The pump applies a defined quantity of NaOH.

**8.13.3 Dosing H<sub>3</sub>BO<sub>3</sub> manually****NOTE**

The quantity of liquid per keystroke can be changed in the *[Settings]* submenu.

**Specifications on the display:**

Precondition:



- A receiving vessel is installed. See Chapter 8.9 "Installing a receiving vessel", page 73

- ▶ Navigate to the specified menu.

- ▶ Tap the specified button.

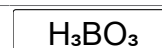

- ⇒ The pump applies a defined quantity of H<sub>3</sub>BO<sub>3</sub>.

**8.14 Aspirating manually****8.14.1 Aspirating the sample tube manually****NOTE**

The aspiration time per keystroke can be changed in the *Settings* submenu.

**Specifications on the display:**

- ▶ Navigate to the specified menu.



**Specifications on the display:**

- ▶ Tap the specified button. [Sample Tube Aspiration]
- ⇒ The pump aspirates liquid from the sample tube.







**8.14.2 Aspirating the receiving vessel manually****NOTE**

The aspiration time per keystroke can be changed in the *Settings* submenu.

**Specifications on the display:**

- ▶ Navigate to the specified menu. 
- ▶ Tap the specified button. [Receiver Aspiration]
- ⇒ The pump aspirates liquid from the receiving vessel.

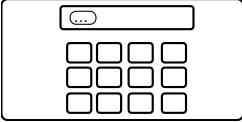
**8.15 Changing the stirring speed manually****Specifications on the display:**

- ▶ Navigate to the specified submenu.   
↓  

- ▶ Select the specified action. 
- ▶ Tap the specified function on the function bar. 
- ▶ Enter the stirring speed. 
- ▶ Tap the specified function on the function bar. 
- ⇒ The stirring speed is saved.



## 9 Carrying out a determination

### 9.1 Preparing the instrument

#### Navigation path

---



Precondition:

- All commissioning operations have been completed. See Chapter 5 "Installation", page 29
- ▶ Set the On/Off master switch to On.
  - ⇒ The instrument is starting up.
- ▶ Make sure that no defective sealings or glass parts are used.
- ▶ Navigate to the *Home* menu according the navigation path.
- ▶ Tap the *[READY]* button on the function bar.
  - ⇒ The instrument is heating up.
- ▶ Install a receiving vessel (EasyKjel and BasicKjel only). See Chapter 8.9 "Installing a receiving vessel", page 73
- ▶ Install the sample tube. See Chapter 8.8 "Installing the sample tube", page 72
- ▶ Close the protection shield.
- ▶ Flush the tubing. See Chapter 8.13 "Dosing manually", page 74
- ▶ Aspirate the receiving and the sample vessels. See Chapter 8.14 "Aspirating manually", page 75

### 9.2 Starting a determination

#### Navigation path

---

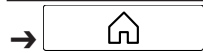

Precondition:

- The instrument is prepared. See Chapter 9.1 "Preparing the instrument", page 78
- The sample is prepared.
- The connected instruments are prepared (MultiKjel only). See related documentation.
- ▶ Navigate to the *Home* menu according the navigation path.
- ▶ Press the *[PREP]* button on the function bar.
  - ⇒ Wait until the status bar shows the status **READY**.
- ▶ Select the operation mode. See Chapter 8.12 "Selecting the operation mode", page 74
- ▶ Tap the *[START]* button on the function bar.

## 9.3 Ending a determination

### Navigation path



Precondition:

- The display shows the *Finished* dialog.
- ▶ Confirm the message on the dialog.

## 9.4 Shutting down the instrument

Precondition:

- The extraction process has ended.
- ▶ Shut down the connected instruments (MultiKjel only). See related documentation.
- ▶ Clean the instrument. See Chapter 10.3 "Cleaning the glass components", page 83
- ▶ Install an empty sample tube. See Chapter 8.8 "Installing the sample tube", page 72
- ▶ Install an empty receiving vessel (EasyKjel and BasicKjel only). See Chapter 8.9 "Installing a receiving vessel", page 73
- ▶ Set the On/Off master switch to Off.

## 9.5 Filtering determination data

### Specifications on the display:

▶ Navigate to the specified menu.	
▶ Select the specified action.	Filter by
▶ Select the filter you wish to use.	

## 9.6 Showing determination data

▶ Navigate to the specified submenu.	
▶ Select the determination you wish to view. ⇒ The display shows the data of the determination.	

## 9.7 Deleting determination data

### 9.7.1 Deleting one determination

### Specifications on the display:

▶ Navigate to the specified menu.	
▶ Select the determination you wish to delete.	

**Specifications on the display:**

▶ Tap the specified function on the function bar. 

▶ Confirm the secure question.  
⇒ The determination data is deleted.

**9.7.2 Deleting all determination data**

**Specifications on the display:**

▶ Navigate to the specified menu. 

▶ Tap the specified function on the function bar. 

▶ Confirm the secure question.  
⇒ All determination data are deleted.

**9.8 Exporting determination data (Interface pro only)**

**9.8.1 Exporting one determination (Interface pro only)**

**Specifications on the display:**

Precondition: 

A storage medium is available. See Chapter "Settings submenu", page 48

▶ Navigate to the specified menu.

▶ Select the determination you wish to export. 

▶ Tap the specified function on the function bar. 

**9.8.2 Exporting all determination data (Interface pro only)**

**Specifications on the display:**

▶ Navigate to the specified menu. 

▶ Tap the specified function on the function bar. 



## 10 Cleaning and servicing



### NOTE

Users may only carry out the servicing and cleaning operations described in this section.

Any servicing and repair work which involves opening up the casing may only be carried out by BUCHI service technicians.

- ▶ Use only genuine BUCHI consumables and spare parts in order to ensure correct operation of the device and preserve the warranty.

## 10.1 Regular maintenance work

Action		Daily	Weekly	Monthly	Yearly	Additional information
10.2	Cleaning and servicing the sample tube	1				Carry out this action before every instrument use.
10.3	Cleaning the glass components	1				Carry out this action after every instrument use.
10.4	Cleaning and servicing the hoses and hose connections		2			
10.5	Cleaning and servicing the sample tube seal		2			Replace the sample tube seal twice per year
10.6	Cleaning and servicing the splash protector		2			Replace the glass splash protector after ~ 3500 distillations (twice per year). Replace the plastic splash protector once in 2 years.
10.7	Cleaning and servicing the steam inlet and condenser outlet tube		2			Replace the tube once per year.
10.8	Cleaning the housing		2			
10.9	Cleaning and servicing the warning and directive symbols		2			
10.10	Cleaning and servicing the bridge splash protector to condenser		2			Replace the bridge once per year.
10.11	Cleaning and servicing the dosing pumps		2			Replace the NaOH pump once per year
10.12	Cleaning and servicing the condenser			2		
10.13	Cleaning and servicing the steam generator			2		
10.14.1	Calibrating the H <sub>2</sub> O pump			2		
10.14.2	Calibrating the acid pump			2		
10.14.3	Calibrating the NaOH pump			2		
10.14.4	Calibrating the H <sub>3</sub> BO <sub>3</sub> Pump			2		
10.15	Decalcifying the instrument				2	

1 - User; 2 - Operator

## 10.2 Cleaning and servicing the sample tube

- ▶ Before using, check the sample tube for defects (cracks/splintering).
- ▶ Prevent temperature shocks on the sample tubes.
- ⇒ Temperature shocks may lead to breakage.

## Cleaning

If cleaning with a dishwashing machine:

- ▶ Make sure, that there is no contact with other glassware.





## Storage (e.g. drawer)

- ▶ Prevent rolling and small hits.
  - ⇒ This can cause hair cracks which may lead to breakages.

## 10.3 Cleaning the glass components

The following values for the cleaning can be adjusted (the list differs according to the instrument configuration):

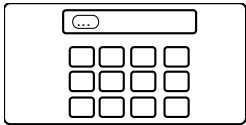
- [H<sub>2</sub>O Volume]
- [Steam Power]
- [Distillation Time]
- [Sample Tube Aspiration]
- [Receiver Aspiration]

	Specifications on the display:
Precondition:	
<input checked="" type="checkbox"/> A sample tube is installed. See Chapter 8.8 "Installing the sample tube", page 72	⋮
<input checked="" type="checkbox"/> A sample receiving vessel is installed. See Chapter 8.9 "Installing a receiving vessel", page 73	
▶ Navigate to the specified submenu.	
▶ Adjust the values according to your needs.	
▶ Confirm the entries with the specified function in the function bar.	
▶ Tap the specified function on the function bar.	

## 10.4 Cleaning and servicing the hoses and hose connections

- ▶ Check the hoses and hose connections for defects (cracks, brittle areas).
- ▶ If defective, replace the hoses.

## 10.5 Cleaning and servicing the sample tube seal

- ▶ Check the seal for the following damage that may cause leakage:
  - Deterioration (surface roughness)
  - Deformation (rubber shape)
  - Residues (dirt, white crystals)
- ▶ Rinse the seal with water.

- ▶ If necessary, replace the seal. See Chapter 10.21 "Replacing the sample tube seal", page 90

## 10.6 Cleaning and servicing the splash protector

- ▶ Check for leaks on the connectors.
- ▶ Check for residues inside the splash protector.
- ▶ Check the glass wall of the main body and the connectors.
  - ⇒ If the part is dirty, clean it with detergents.
  - ⇒ If the glass part is showing deterioration (transparency loss/reams in the glass wall) or leakages (white residues), replace it.

## 10.7 Cleaning and servicing the steam inlet and condenser outlet tube

- ▶ Check the tubes concerning dirt or residues.
- ▶ Clean and replace periodically depending on the use.

## 10.8 Cleaning the housing

- ▶ Wipe down the housing with a damp cloth.
- ▶ If heavily soiled, use ethanol or a mild detergent.
- ▶ Wipe down the display with a damp cloth.

## 10.9 Cleaning and servicing the warning and directive symbols

- ▶ Check that the warning symbols on the instrument are legible.
- ▶ If they are dirty, clean them.

## 10.10 Cleaning and servicing the bridge splash protector to condenser

- ▶ Check if it is tight.
- ▶ Check for residues inside the tube.
- ▶ If necessary, clean it with a brush and water.

## 10.11 Cleaning and servicing the dosing pumps

- ▶ Check the pump connectors in the dosing pump window for:
  - Leakages
  - Crystallization
- ▶ If necessary, contact BUCHI customer service.

## 10.12 Cleaning and servicing the condenser

### **Decalcification solution:**

---

160 g citric acid or 80 g amidosulfuric acid dissolved in 0.8 L water.

---

- ▶ Check if the cooling media of the condenser is transparent.

- ▶ Check if the inside of the coil is showing condensation droplets.
  - ⇒ If droplets appear:
    - Flush the condenser coil through the condensate expansion vessel with an 1% hydrochloric acid.
    - Flush the condenser coil through the condensate expansion vessel with water and water/ethanol mixture.
- ▶ Clean the condenser on the outside of the coil (water connectors) with decalcification solution to remove chalk, algae, and rust.

### 10.13 Cleaning and servicing the steam generator

- ▶ Check the distillation volume.
  - ⇒ If the condensate amount is less than 160 mL water/per 5 minutes distillation (after preheating), decalcify the instrument. See Chapter 10.15 "Decalcifying the instrument", page 87







### 10.14 Calibrating the pumps

#### 10.14.1 Calibrating the H<sub>2</sub>O pump

	Specifications on the display:												
Precondition:													
<input checked="" type="checkbox"/> A sample tube is installed. See Chapter 8.8 "Installing the sample tube", page 72	↓												
▶ Navigate to the specified submenu.	<div style="border: 1px solid black; padding: 2px; display: inline-block;">Pump Calibration &gt;</div>												
	↓												
	<div style="border: 1px solid black; padding: 2px; display: inline-block;">H<sub>2</sub>O &gt;</div>												
▶ Select the specified action.	<div style="border: 1px solid black; padding: 2px; display: inline-block;">Nominal Volume ...</div>												
▶ Tap the specified function on the function bar.	<b>EDIT</b>												
▶ Enter the calibration volume you wish to use.	<div style="border: 1px solid black; padding: 5px; display: inline-block;"> <input style="width: 100px; height: 20px; margin-bottom: 5px;" type="text"/>  <table border="1" style="border-collapse: collapse; text-align: center; width: 100%;"> <tr><td> </td><td> </td><td> </td><td> </td></tr> <tr><td> </td><td> </td><td> </td><td> </td></tr> <tr><td> </td><td> </td><td> </td><td> </td></tr> </table> </div>												
▶ Tap the specified function on the function bar.	<b>START</b>												
▶ Wait until the display shows a numeric dialog.	<div style="border: 1px solid black; padding: 5px; display: inline-block;"> <input style="width: 100px; height: 20px; margin-bottom: 5px;" type="text"/>  <table border="1" style="border-collapse: collapse; text-align: center; width: 100%;"> <tr><td> </td><td> </td><td> </td><td> </td></tr> <tr><td> </td><td> </td><td> </td><td> </td></tr> <tr><td> </td><td> </td><td> </td><td> </td></tr> </table> </div>												
▶ Remove the sample tube.													
▶ Measure the volume in the sample tube.													
▶ Enter the value in the numeric dialog.													
▶ Tap the specified function on the function bar.	<b>SAVE</b>												

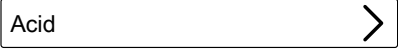

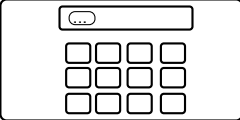



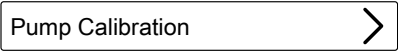

### 10.14. Calibrating the acid pump

2

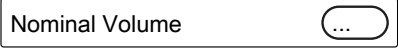
	Specifications on the display:
Precondition:	
<ul style="list-style-type: none"> <li>☑ A sample tube is installed. See Chapter 8.9 "Installing a receiving vessel", page 73</li> </ul>	↓
▶ Navigate to the specified submenu.	
▶ Select the specified action.	
▶ Tap the specified function on the function bar.	
▶ Wait until the display shows a numeric dialog.	
▶ Remove the sample tube.	
▶ Measure the volume in the sample tube.	
▶ Enter the value in the numeric dialog.	
▶ Tap the specified function on the function bar.	

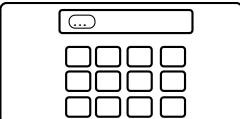

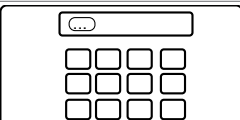



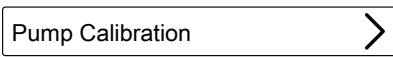

### 10.14. Calibrating the NaOH pump

3

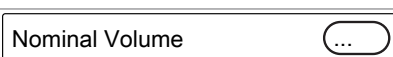
	Specifications on the display:
Precondition:	
<ul style="list-style-type: none"> <li>☑ A sample tube is installed. See Chapter 8.9 "Installing a receiving vessel", page 73</li> </ul>	↓
▶ Navigate to the specified submenu.	
	↓
	
▶ Select the specified action.	
▶ Tap the specified function on the function bar.	
▶ Enter the calibration volume you wish to use.	
▶ Tap the specified function on the function bar.	
▶ Wait until the display shows a numeric dialog.	
▶ Remove the sample tube.	
▶ Measure the volume in the sample tube.	
▶ Enter the value in the numeric dialog.	
▶ Tap the specified function on the function bar.	

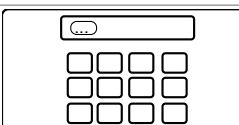
## 10.14. Calibrating the H<sub>3</sub>BO<sub>3</sub> Pump

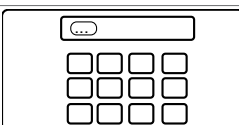
4

	Specifications on the display:
Precondition:	
<input checked="" type="checkbox"/> A receiving vessel is installed. See Chapter 8.9 "Installing a receiving vessel", page 73 ▶ Navigate to the specified submenu.	↓ 
▶ Select the specified action.	↓ 
▶ Tap the specified function on the function bar.	
▶ Enter the calibration volume you wish to use.	
▶ Tap the specified function on the function bar.	
▶ Wait until the display shows a numeric dialog.	
▶ Remove the sample receiving vessel.	
▶ Measure the volume in the sample receiving vessel.	
▶ Enter the measured volume.	
▶ Tap the specified function on the function bar.	

## 10.15 Decalcifying the instrument

Time required: approximately 2.5 hours

### Decalcification solution:

160 g citric acid or 80 g amidosulfuric acid dissolved in 0.8 L water.

#### Precondition:

- The instrument temperature is the same as the ambient temperature.
- ▶ Remove the water from the instrument. See Chapter 12.4 "Removing water from the steam generator", page 98
- ▶ Prepare the decalcification solution.
- ▶ Install a suitable hose to the H<sub>2</sub>O supply for steam generation.
- ▶ Put the other end of the hose in the decalcification solution.
- ▶ Set the On/Off master switch to On.
- ▶ Press the [READY] button on the function bar.
- ▶ Wait until the pumps stop working.
- ▶ Set the On/Off master switch to Off.
- ▶ Wait 30 minutes.

- ▶ Remove the decalcification solution from the instrument. See Chapter 12.4 "Removing water from the steam generator", page 98
- ▶ Do steps (5) thru (10) again.
- ▶ Install the H<sub>2</sub>O supply for steam generation.
- ▶ Set the On/Off master switch to On.
- ▶ Press the [READY] button on the function bar.
- ▶ Wait until the pumps stop working.
- ▶ Set the On/Off master switch to Off.
- ▶ Remove the water from the instrument. See Chapter 12.4 "Removing water from the steam generator", page 98
- ▶ Do steps (11) thru (16) five times.

## 10.16 Replacing the splash protector



### NOTE

Installing is done in reverse sequence.

- ▶ Remove the protection shield. See Chapter 10.18 "Attaching and removing the protection shield", page 89

- ▶ Loosen the cap nut at the splash protector.

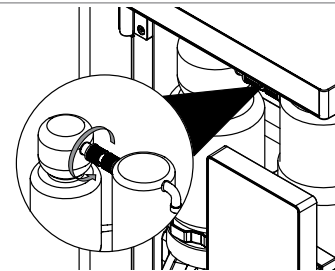

- ▶ Open the splash protector nut.

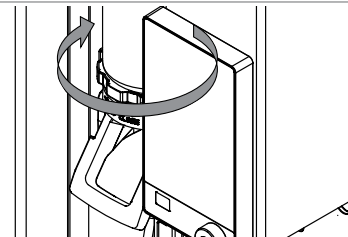

- ▶ Remove the splash protector.

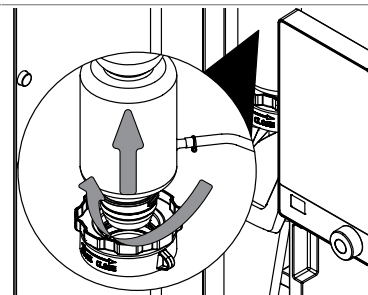

- ▶ Remove the steam connection.
- ▶ Remove the NaOH/acid connection (according to the instrument configuration).

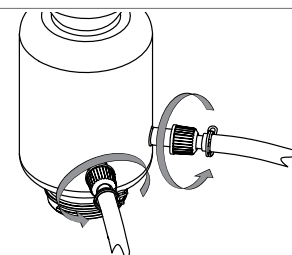



## 10.17 Replacing the condenser



### NOTE

Installing is done in reverse sequence.

- ▶ Remove the protection shield. See Chapter 10.18 "Attaching and removing the protection shield", page 89
- ▶ Loosen the cap nut at the condenser.

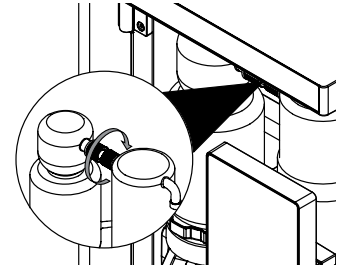

- ▶ Remove the cooling water hoses.

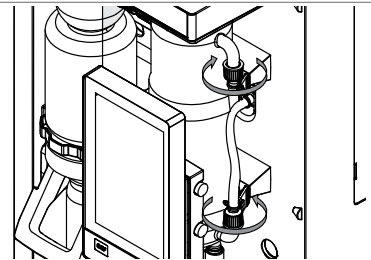

- ▶ Remove the rubber band.

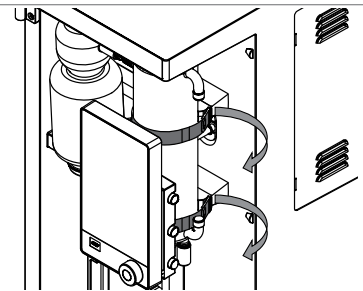

## 10.18 Attaching and removing the protection shield

### 10.18. Removing the protection shield

1

- ▶ Pull the protection shield from the instrument.

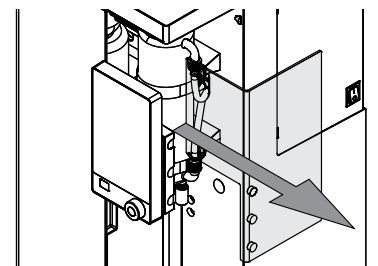

### 10.18. Attaching the protection shield

2

- ▶ Attach the protection shield onto the instrument.

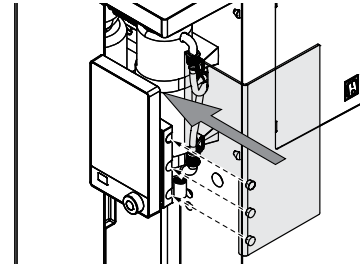

### 10.19 Cleaning the drip tray

- ▶ Pull the drip tray.
- ▶ Rinse the drip tray with water.

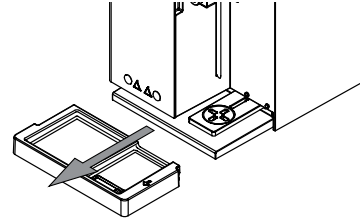

### 10.20 Rinsing a pump

Precondition:

- A sample tube is installed. See Chapter 8.8 "Installing the sample tube", page 72
- ▶ Put the side of the hose in distilled water.
- ▶ Apply 100 mL with the manual functions. See Chapter 8.13 "Dosing manually", page 74

### 10.21 Replacing the sample tube seal



#### NOTE

Installing is done in reverse sequence.



#### NOTE

Make the seal moist with water before installation.

- ▶ Remove the protection shield. See Chapter 10.18.1 "Removing the protection shield", page 89
- ▶ Loosen the cap nut.

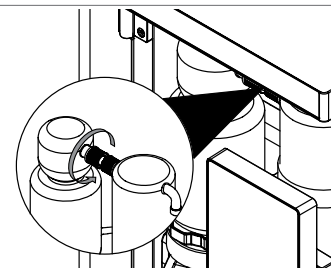

► Open the splash protector nut.

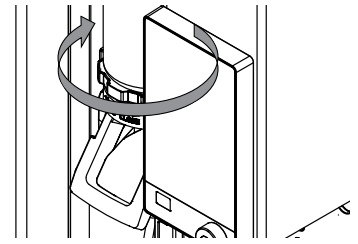

► Remove the splash protector.

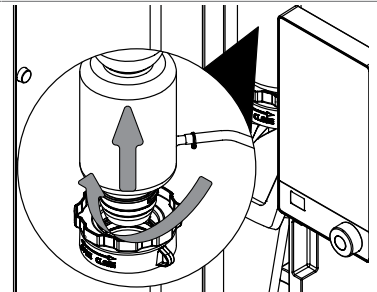

► Remove the seal.

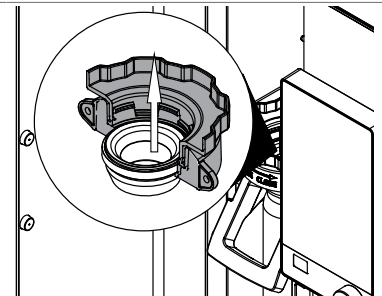
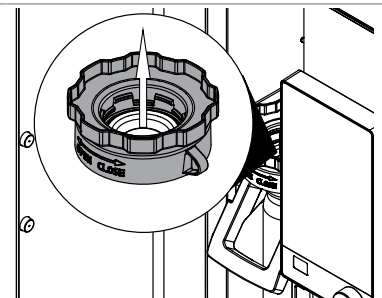

## 11 Help with faults

### 11.1 Troubleshooting digestion

Problem	Possible cause	Action
Crystallization after digestion	False ratio of H <sub>2</sub> SO <sub>4</sub> to catalyst.	▶ Use KjelOptimizer software to optimize the digestion (download available on BUCHI website).
	Digestion time too long.	▶ Decrease digestion time. ▶ Compare to conditions to similar applications.
	Suction capacity of scrubber too strong.	▶ Lower the suction capacity on the scrubber. See "Scrubber " operation manual
Samples do not get clear	No or not enough catalyst used.	▶ Use KjelOptimizer software to optimize the digestion (download available on BUCHI website).
	Digestion temperature is too low.	▶ Decrease digestion time. ▶ Compare to conditions to similar applications.
	Temperature is too high.	▶ Decrease digestion temperature.
	Sealing material was flushed into the sample.	▶ Check the sealing.
	Fume leakage	The seals are defective.
Fume leakage	Suction capacity of scrubber is too weak.	▶ Carry out the scrubber maintenance. See "Scrubber " operation manual
	Leakage in the system, e.g. hose connector not tight.	▶ Check connections between digester and scrubber.
	Blocked hoses.	▶ Clean the hoses.
	Reduced suction on the bypass valve.	
Boiling retardation/ bumping/foaming	Missing digestion rods or boiling stones.	▶ Add boiling rods during digestion.
	Missing antifoam tablet or other anti-foaming agent.	▶ Add antifoam tablet.

Problem	Possible cause	Action
Samples do not get dark blue/brown after addition of NaOH	Air in NaOH hose.	▶ Flush the system. See Chapter 8.13 "Dosing manually", page 74
	No catalyst used for digestion (only H <sub>2</sub> O <sub>2</sub> or Kjeldahl tablets ECO).	

## 11.2 Troubleshooting distillation

Problem	Possible cause	Action
Splashing during distillation or addition of chemicals	The sample tube is too small.	▶ Select a bigger sample tube.
	Sample volume too high.	▶ Lower sample volume.
	Amount of water used for dilution is too low.	▶ Increase dilution volume.
Measured nitrogen content is too high	Air in titration system, burette or tubes.	▶ Tighten the connections. ▶ Flush the tubing with titrant. ▶ Refill burette.
	Carry over during distillation.	▶ Insert less sample. ▶ Avoid big concentration differences in measurement series.
	Titrant concentration too high.	▶ Lower the titrant concentration.
	Error in calculation.	▶ Check calculation. ▶ Check titration parameters. ▶ Check the titer for the titrant in use.
	pH electrode is defective.	▶ Maintain electrode. See related documentation ▶ If necessary, replace it.
	The glassware is dirty.	▶ Clean the glassware. See Chapter 10.2 "Cleaning and servicing the sample tube", page 82

<b>Problem</b>	<b>Possible cause</b>	<b>Action</b>
Measured nitrogen content is too low	Incomplete digestion.	<ul style="list-style-type: none"> <li>▶ Increase digestion time.</li> <li>▶ Use different Kjeldahl tablet.</li> </ul>
	The H <sub>2</sub> SO <sub>4</sub> volume is too low.	<ul style="list-style-type: none"> <li>▶ Use KjelOptimizer software to optimize the digestion (download available on BUCHI website).</li> </ul>
	Kjeldahl Tablets and H <sub>2</sub> SO <sub>4</sub> in wrong ratio.	<ul style="list-style-type: none"> <li>▶ Correct ratio of Kjeldahl Tablets and H<sub>2</sub>SO<sub>4</sub>.</li> <li>▶ Use KjelOptimizer software to optimize the digestion (download available on BUCHI website).</li> </ul>
Nitrogen content per sample tube is too high.		<ul style="list-style-type: none"> <li>▶ Not apply more than 200 mg Nitrogen per sample tube.</li> <li>▶ Use KjelOptimizer software to optimize the digestion (download available on BUCHI website).</li> </ul>
		<ul style="list-style-type: none"> <li>▶ Correct volume for complete alkalization of the digested sample.</li> </ul>
Leakage during distillation.		<ul style="list-style-type: none"> <li>▶ Check connection between condenser and splash protector.</li> <li>▶ Tighten the connection.</li> <li>▶ If necessary, replace it.</li> </ul>
		<ul style="list-style-type: none"> <li>▶ Check titer of titrant.</li> </ul>
		<ul style="list-style-type: none"> <li>▶ Maintain electrode. See related documentation</li> <li>▶ If necessary, replace it.</li> </ul>
The glassware is dirty.		<ul style="list-style-type: none"> <li>▶ Clean the glassware. See Chapter 10.2 "Cleaning and servicing the sample tube", page 82</li> </ul>
Incorrect weighing.		<ul style="list-style-type: none"> <li>▶ Use weighing boats (easy sample transfer from balance to sample tube).</li> <li>▶ Use anti-static equipment.</li> <li>▶ Use larger sample sizes.</li> </ul>

<b>Problem</b>	<b>Possible cause</b>	<b>Action</b>
Poor repeatability	Air bubbles in titration system, burette, tubes.	<ul style="list-style-type: none"> <li>▶ Tighten the connections.</li> <li>▶ Flush the tubing with titrant.</li> <li>▶ Refill burette.</li> </ul>
	Aspiration not working properly.	<ul style="list-style-type: none"> <li>▶ Check for leaks.</li> <li>▶ Tighten the connections.</li> </ul>
	Sample is inhomogeneous.	<ul style="list-style-type: none"> <li>▶ Homogenize the sample.</li> </ul>
	Sample weighing problems.	<ul style="list-style-type: none"> <li>▶ Use weighing boats (easy sample transfer from balance to sample tube).</li> <li>▶ Use anti-static equipment.</li> <li>▶ To decrease the degree of error, keep the weighed sample portion as high as possible.</li> </ul>
	Incomplete digestion, digestion time too short.	<ul style="list-style-type: none"> <li>▶ Choose digestion time accordingly.</li> <li>▶ Check color of samples during digestion.</li> <li>⇒ Solution should be transparent by the end of the digestion.</li> </ul>
	Stirrer is defective.	<ul style="list-style-type: none"> <li>▶ Clean the stirrer.</li> <li>▶ If necessary, replace the stirrer.</li> </ul>
	Loose contact of the sensor cables.	<ul style="list-style-type: none"> <li>▶ Check the sensor cables.</li> </ul>

### 11.3 Troubleshooting instrument

<b>Problem</b>	<b>Possible cause</b>	<b>Action</b>
The instrument does not work	The installation site has no power supply.	<ul style="list-style-type: none"> <li>▶ Check the power supply of the installation site.</li> </ul>
	The instrument is not connected to the power supply.	<ul style="list-style-type: none"> <li>▶ Connect the instrument to the power supply. See Chapter 5.2 "Establishing electrical connections", page 29</li> </ul>
	The power supply cable is defect.	<ul style="list-style-type: none"> <li>▶ Replace the power supply cable.</li> </ul>
	The fuse was triggered.	<ul style="list-style-type: none"> <li>▶ Reset the fuse</li> </ul>
	The switch is defect.	<ul style="list-style-type: none"> <li>▶ Contact BUCHI Customer Service.</li> </ul>

Problem	Possible cause	Action
Steam generator is not reaching the status <b>Ready</b>	Not enough water in the steam generator.	<ul style="list-style-type: none"> <li>▶ Make sure, that the installation H<sub>2</sub>O supply for steam generation is correct.</li> <li>▶ Make sure, that there is enough water in the canister.</li> <li>▶ Make sure, that the hose is submerged in the water.</li> <li>▶ Check for leaks between instrument and canister.</li> <li>▶ Check water level status in the steam generator.</li> </ul>
Display is black	The connection between instrument and display is interrupted.	<ul style="list-style-type: none"> <li>▶ Check the connection cable from the instrument to the display.</li> <li>▶ Contact BUCHI Customer Service.</li> </ul>
No cooling water flow	The cooling water supply is blocked.	<ul style="list-style-type: none"> <li>▶ Make sure, that the hoses are not bend.</li> <li>▶ Check for leaks between instrument and cooling water source.</li> </ul>
	Water flow sensor blocked.	<ul style="list-style-type: none"> <li>▶ Clean the hoses.</li> </ul>
Dosing pump is not feeding	Not enough liquid for feeding.	<ul style="list-style-type: none"> <li>▶ Make sure, that the installation is correct.</li> <li>▶ Make sure, that there is enough liquid in the canister.</li> <li>▶ Make sure, that the hose is submerged in the liquid.</li> <li>▶ Check for leaks between instrument and canister.</li> <li>▶ Make sure that liquid is inside the pump.</li> </ul>
Aspiration is not working	Leaks	<ul style="list-style-type: none"> <li>▶ Check the hoses connected with the pump for leaks and deterioration.</li> </ul>
	The aspiration pump is defect.	<ul style="list-style-type: none"> <li>▶ Check if the wheel inside the pump is turning.</li> <li>▶ Contact BUCHI Customer Service.</li> </ul>



## 11.4 Turning the splash protector nut

- ▶ Turn the splash protector nut.

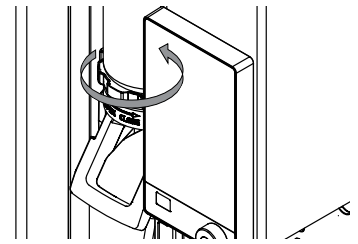

## 12 Taking out of service and disposal

### 12.1 Taking out of service

- ▶ Rinse all pumps. See Chapter 10.20 "Rinsing a pump", page 90
- ▶ Remove the water from the steam generator. See Chapter 12.4 "Removing water from the steam generator", page 98
- ▶ Remove all reagents and coolants.
- ▶ Clean the instrument.
- ▶ Set the On/Off master switch to Off.
- ▶ Disconnect the power supply.
- ▶ Remove all tubing and cables from the instrument.

### 12.2 Disposal

The operator is responsible for proper disposal of the instrument.

- ▶ When disposing of equipment observe the local regulations and statutory requirements regarding waste disposal.
- ▶ When disposing, observe the disposal regulations of the materials used. Materials used see Chapter 3.5 "Technical data", page 24

### 12.3 Returning the instrument

Before returning the instrument, contact the BÜCHI Labortechnik AG Service Department.

<https://www.buchi.com/contact>

### 12.4 Removing water from the steam generator

Precondition:

- The On / Off master switch is set to Off.
- ▶ Install a drain hose to the connection marked **Steam Generator OUT**.
- ▶ Put the other end of the hose in a sink.

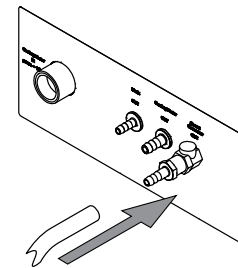



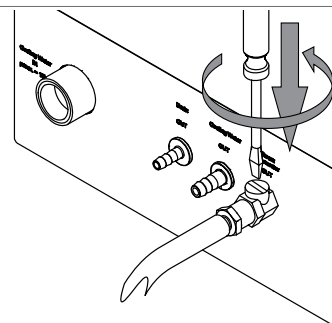

- ▶ Open the valve.



## 13 Appendix

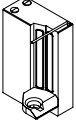
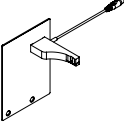
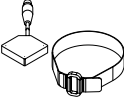
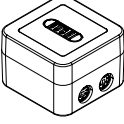
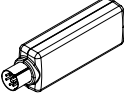

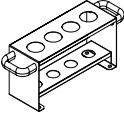
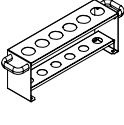
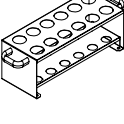

### 13.1 Spare parts and accessories

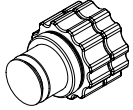
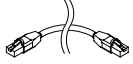

#### 13.1.1 Accessories

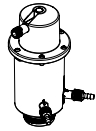
	Order no.	Image
Reaction detection sensor	11072666	
OnLevel sensor	11070270	
Tank level sensor kit	11072294	
Eco Titrator	11072748	
StatusLight cpl., incl. communication cable Indicates the status of the instrument (instrument is ready to use, has an error or is in operation).	11068959	
BUCHI Bluetooth® Dongle, connects instrument to smartphone via Bluetooth®	11067770	
Adapter for 3rd party sample tubes	11072398	
Sample tube holder (4x 500 mL tubes)	016951	
Sample tube holder (6 x 300 mL tubes)	043039	
Sample tube holder (12 x 300 mL tubes)	043041	
SO <sub>2</sub> absorption glass set	11073599	

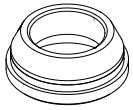
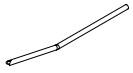

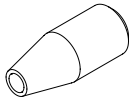
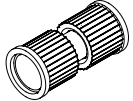
	Order no.	Image
Cyanide caps Caps for hermetical closing of all types of Kjeldahl sample tubes during sample preparation for cyanide in food	11067871	
Communication cable RJ45, 2 m Connection between vacuum controller/interface and recirculating chiller, vacuum controller/interface and vacuum pump or steam distillation unit and Eco titrator.	044989	
Dispenser unit Titronic 300	11062956	

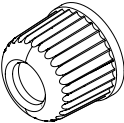
### 13.1.2 Splash protector spare parts

	Order no.	Image
Glass splash protector	11071013	
Plastic splash protector	11070670	
Devarda splash protector	11071014	
Sealing sample tube to splash protector	043068	
Steam inlet tubing to sample tube	043424	
Steam inlet tubing to sample tube (750 mL)	043119	
Connecting piece	019002	
Bridge splash protector to condenser	11070620	

	Order no.	Image
Cap nut GL14	033577	
Hose barbs. set. 4 pcs, straight, GL14, FPM seal Content: Hose barbs, cap nuts, seals.	040296	
Seals, set. 10 pcs, for hose barbs GL14, FPM, green	040040	

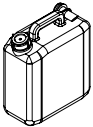
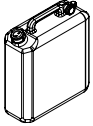
### 13.1.3 Tank spare parts

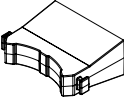
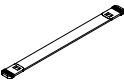
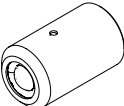

	Order no.	Image
Cap Set, 10 L tank	11072173	
Canister 10L thin walled	043410	
Cap Set, 20 L tank	11072174	
Canister 20L	043408	
Tank labels	043434	

### 13.1.4 Condenser spare parts





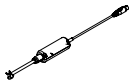
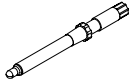
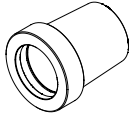
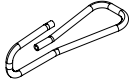

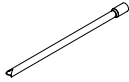
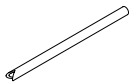
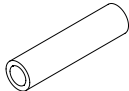
	Order no.	Image
Condenser with check valve	11072183	
Clamp for condenser	11066868	
Rubber band	11070669	
Check valve	11071740	

	Order no.	Image
Dist. Outlet PTFE L=300	11071940	

### 13.1.5 Titration spare parts

	Order no.	Image
Receiving vessel	043390	
Stirrer cpl.	11070246	
pH electrode (refillable electrolyte)	11065834	
pH Electrode	11056842	
Clamp cone pH-electrode	11069793	
Hose Tygon Ø 8.0 x 4.8	043364	
Receiving support	11071003	
Dist. Outlet PTFE L=212	11071941	
Aspiration tubing receiving vessel	11072589	
H <sub>3</sub> BO <sub>3</sub> tubing receiving vessel	11072637	



### 13.1.6 Sample tubes

	Order no.	Image
Sample tubes micro (100 mL) 4 pcs.	11057442	
Sample tubes 300 mL 20 pcs.	11059690	
Sample tubes 300 mL For sample volumes up to 200 mL or 5 g in weight 4 pcs.	037377	
Sample tubes graduated 300 mL 4 pcs.	043049	
Sample tube 500 mL	026128	
Sample tubes 500 mL 4 pcs.	043982	
Sample tube 750 mL including suction tube	11058999	

### 13.1.7 Cable and tubing

	Order no.
Hose peristaltic pump out (2.5 m)	11071630
Hose clips peristaltic pump hose	043586
Hose to NaOH/ H <sub>2</sub> O/H <sub>3</sub> BO <sub>3</sub> pumps or drain (2 m)	11072687
Hose clip to NaOH/H <sub>2</sub> O/ H <sub>3</sub> BO <sub>3</sub> pumps or drain	043841
Suction to tube tank (0.58 m)	043407
Tap water hose cpl.	037780
Cable to Metrohm Titrino Plus 877/848 titrator	11055333
Set of sealings tap water hose	040043
Cable to SI-Analytics TitroLine Easy and TitroLine 5000 titrator	043618

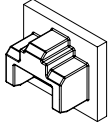
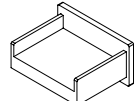
### 13.1.8 Other spare parts

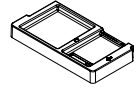
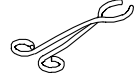
	Order no.	Image
Cap RJ-45 cap	11055949	
USB cover	11069375	
Level sensor capacitive	11065245	
Tank level sensor (Velcro point)	11070517	
Tank level sensor (Velcro strap)	11070516	
Silicone hose D6/9 L=3 m	048355	
Collecting pan	11066465	
Pair of glass tongs	002004	

### 13.1.9 Consumables

	Order no.
2% boric acid pH 4.65 +/- 0.15 with Sher indicator, 5 L	11064972
4% boric acid pH 4.65 +/- 0.15 with Sher indicator, 5 L	11064973
4% boric acid pH 4.65 +/- 0.15 with bromocresol green / methly red mixed indicator, 5 L	11064976
Sher indicator 100 mL	003512
Ammonium phosphate monobasic, 25 g	045527

#### 13.1.1 Maintenance kit

0

	Order no.
Customer Kit for Kjel Line	11073024

#### 13.1.1 Upgrade kits

1

	Order no.
Upgrade Basic base unit with aspiration pump	11CSN12157
Upgrade Basic base unit and aspiration pump with I-300 Pro	11CSN12158
Upgrade Basic base unit with aspiration pump and I-300 Pro	11CSN12159



	<b>Order no.</b>
Upgrade Multi base unit with titration vessel	11CSN12160
Upgrade MultiKjel to MultiDist	11CSN12161

### 13.1.1 Documentation

#### 2

	<b>Order no.</b>
IQ/OQ Kit Kjel Line	11073604
Repeating OQ Kjel Line	11073605
Kjeldahl Knowledge Base (EN) Comprehensive guide covering all aspects of the theoretical and practical know-how.	11595478
Kjeldahl Practice Guide (EN) Provides theoretical background information, useful hints and calculation tables for daily routine work	11592548
Kjeldahl Practice Guide (DE)	11592547
Kjeldahl Practice Guide (CN)	11592549

## BUCHI Affiliates:

### Europe

#### Switzerland/Austria

**BÜCHI Labortechnik AG**  
CH – 9230 Flawil  
T +41 71 394 63 63  
F +41 71 394 64 64  
buchi@buchi.com  
www.buchi.com

#### Italy

**BUCHI Italia s.r.l.**  
IT – 20010 Cornaredo (MI)  
T +39 02 824 50 11  
F +39 02 575 12 855  
italia@buchi.com  
www.buchi.com/it-it

#### Benelux

**BÜCHI Labortechnik GmbH**  
Branch Office Benelux  
NL – 3342 GT Hendrik-Ido-Ambacht  
T +31 78 684 94 29  
F +31 78 684 94 30  
benelux@buchi.com  
www.buchi.com/bx-en

#### Russia

**BUCHI Russia/CIS**  
Russia 127287 Moscow  
T +7 495 36 36 495  
russia@buchi.com  
www.buchi.com/ru-ru

#### France

**BUCHI Sarl**  
FR – 91140 Villebon-sur-Yvette  
T +33 1 56 70 62 50  
F +33 1 46 86 00 31  
france@buchi.com  
www.buchi.com/fr-fr

#### Spain

**BUCHI Ibérica S.L.U.**  
ES – 08960 Barcelona  
T +34 936 06 8010  
iberica@buchi.com  
www.buchi.com/es-es

#### Germany

**BÜCHI Labortechnik GmbH**  
DE – 45127 Essen  
T +800 414 0 414 0 (Toll Free)  
T +49 201 747 49 0  
F +49 201 747 49 20  
deutschland@buchi.com  
www.buchi.com/de-de

#### United Kingdom

**BUCHI UK Ltd.**  
GB – Suffolk CB8 7SQ  
T +44 161 633 1000  
F +44 161 633 1007  
uk@buchi.com  
www.buchi.com/gb-en

### NIR-Online

#### Germany

**BÜCHI NIR-Online**  
DE – 69190 Walldorf  
T +49 6227 73 26 60  
F +49 6227 73 26 70  
nir-online@buchi.com  
www.nir-online.de

### America

#### Brazil

**BUCHI Brasil Ltda.**  
BR – Valinhos SP 13271-200  
T +55 19 3849 1201  
F +55 19 3849 2907  
brasil@buchi.com  
www.buchi.com/br-pt

#### USA/Canada

**BUCHI Corporation**  
US – New Castle, DE 19720  
T +1 877 692 8244 (Toll Free)  
T +1 302 652 3000  
F +1 302 652 8777  
us-sales@buchi.com  
www.buchi.com/us-en

### Asia

#### China

**BUCHI China**  
CN – 200233 Shanghai  
T +86 21 6280 3366  
F +86 21 5230 8821  
china@buchi.com  
www.buchi.com/cn-zh

#### India

**BUCHI India Private Ltd.**  
IN – Mumbai 400 055  
T +91 22 667 75400  
F +91 22 667 18986  
india@buchi.com  
www.buchi.com/in-en

#### Indonesia

**PT. BUCHI Indonesia**  
ID – Tangerang 15321  
T +62 21 537 62 16  
F +62 21 537 62 17  
indonesia@buchi.com  
www.buchi.com/id-in

#### Japan

**Nihon BUCHI K.K.**  
JP – Tokyo 110-0008  
T +81 3 3821 4777  
F +81 3 3821 4555  
nihon@buchi.com  
www.buchi.com/jp-ja

#### Korea

**BUCHI Korea Inc.**  
KR – Seoul 153-782  
T +82 2 6718 7500  
F +82 2 6718 7599  
korea@buchi.com  
www.buchi.com/kr-ko

#### Malaysia

**BUCHI Malaysia Sdn. Bhd.**  
MY – 47301 Petaling Jaya,  
Selangor  
T +60 3 7832 0310  
F +60 3 7832 0309  
malaysia@buchi.com  
www.buchi.com/my-en

#### Singapore

**BUCHI Singapore Pte. Ltd.**  
SG – Singapore 609919  
T +65 6565 1175  
F +65 6566 7047  
singapore@buchi.com  
www.buchi.com/sg-en

#### Thailand

**BUCHI (Thailand) Ltd.**  
TH – Bangkok 10600  
T +66 2 862 08 51  
F +66 2 862 08 54  
thailand@buchi.com  
www.buchi.com/th-th

## BUCHI Support Centers:

#### South East Asia

**BUCHI (Thailand) Ltd.**  
TH-Bangkok 10600  
T +66 2 862 08 51  
F +66 2 862 08 54  
bacc@buchi.com  
www.buchi.com/th-th

#### Middle East

**BÜCHI Labortechnik AG**  
UAE – Dubai  
T +971 4 313 2860  
F +971 4 313 2861  
middleeast@buchi.com  
www.buchi.com

#### Latin America

**BUCHI Latinoamérica S. de R.L. de C.V.**  
MX – Mexico City  
T +52 55 9001 5386  
latinoamerica@buchi.com  
www.buchi.com/es-es

We are represented by more than 100 distribution partners worldwide.  
Find your local representative at: [www.buchi.com](http://www.buchi.com)