



DOC024.52.93001

ORBISPHERE Model 410 Analyzer

USER MANUAL

11/2018, Edition 16

Section 1 General Information	5
1.1 Disclaimer	5
1.2 Safety information	5
1.2.1 Use of hazard information	5
1.2.2 Safety precautions	5
1.2.3 Service and repairs	6
1.2.4 Precautionary labels.....	6
1.2.5 Operating altitude.....	7
1.2.6 Intended use of this equipment.....	7
1.3 Product recycling information.....	8
1.4 Product disposal	10
1.5 Restriction of hazardous substances (RoHS).....	11
Section 2 Specifications	13
2.1 Technical specifications	13
2.2 Hardware description	14
2.3 Model identification system.....	14
2.4 Security level table	15
2.5 Default parameters	16
Section 3 Installation	17
3.1 Unpacking	17
3.2 Installation check list.....	18
3.3 Wall mount and pipe mount instruments.....	19
3.3.1 Instrument dimensions	19
3.3.2 Wall mounting	20
3.3.3 Pipe mounting	20
3.3.4 Connection panel (bottom of instrument).....	21
3.4 Panel mount instrument.....	21
3.4.1 Instrument dimensions	21
3.4.2 Mounting	23
3.4.3 Connection panel (bottom of instrument).....	24
3.5 Connectors assembly instructions	25
3.5.1 Cable gland wiring instructions	25
3.6 Connection to mains power supply	26
3.6.1 Power supply connection (low voltage instruments)	26
3.6.2 Power supply connection (high voltage instruments).....	27
3.7 Connections to electronic boards.....	28
3.7.1 Sensor cable	28
3.7.2 Electronic boards connectors.....	29
3.7.3 Main board connections	29
3.7.4 Measurement board	30
3.8 Measurement alarm relays	31
3.9 Sensor installation.....	32
3.9.1 EC Sensors	32
3.9.2 TC Sensors	32
3.10 Define working language	32
3.11 Define security levels	32
Section 4 User Interface	33
4.1 Instrument.....	33
4.2 Touch screen	33
4.2.1 Function keys on the header bar.....	34
4.2.2 Menu navigation.....	35
4.2.3 Rolling list.....	35
4.2.4 Virtual keyboard	35
4.2.5 Identification and authorization level.....	36

Table of Contents

4.2.6 Warning windows	36
4.3 Main menu structure.....	37
Section 5 View Menu	39
5.1 Selection of the view style	40
5.2 Configuration of the view styles.....	41
Section 6 Measurement Menu	43
6.1 Instrument configuration.....	44
6.2 Measurement configuration.....	44
6.3 Measured data storage	47
Section 7 Calibration Menu.....	49
7.1 Definitions.....	51
7.2 EC gas sensor calibration	51
7.2.1 O ₂ sensor calibration	52
7.2.2 O ₃ sensor calibration.....	52
7.3 TC gas sensor calibration.....	53
7.4 Calibration errors (EC and TC sensors).....	54
7.5 Barometric pressure calibration.....	54
7.6 Calibration reports	54
Section 8 Inputs/Outputs Menu.....	55
8.1 Configure snooze	56
8.2 View inputs/outputs	56
8.3 Relays	56
8.4 Analog outputs	57
8.5 Analog output characteristics	61
Section 9 Communication Menu.....	65
9.1 RS-485 simple mode configuration	66
9.1.1 Data available.....	67
9.1.2 Example of use.....	69
9.2 PROFIBUS-DP communication (optional).....	70
9.2.1 Installation	70
9.2.2 Input/Output data.....	71
9.3 USB-A port (host).....	75
9.4 HTTP/TCP-IP	75
9.4.1 Overview	75
9.4.2 PC interface.....	75
9.5 Printer.....	77
9.5.1 Install ferrite on the printer cable	77
9.5.2 Printer error messages	78
Section 10 Security Menu.....	79
10.1 Access rights management.....	79
10.2 Configure security	80
10.3 User management.....	80
10.4 User action log file.....	80
Section 11 Products Menu	81
Section 12 Global Configuration Menu	83
Section 13 Services Menu	85
13.1 Sensor diagnostics	87
13.2 Language selection	88
13.3 Clock	88
13.4 Screen	88
13.5 Buzzer	88

13.6 Boards info.....	88
13.7 Batteries.....	89
13.8 Software download	89
13.9 End application	89
Section 14 Maintenance and Troubleshooting	91
14.1 Instrument maintenance	91
14.2 Troubleshooting	91
14.3 List of events and alarms	92
14.4 Storage, handling and transportation	92
Section 15 Part Lists	93
15.1 Accessories.....	93
15.2 Spare parts	93
Section 16 Glossary	95
16.1 Gas units.....	95
16.2 Generic terms and definitions	95

Section 1 General Information

1.1 Disclaimer

The information in this manual has been carefully checked and is believed to be accurate. However, Hach Lange assumes no responsibility for any inaccuracies that may be contained in this manual. In no event will Hach Lange be liable for direct, indirect, special, incidental, or consequential damages resulting from any defect or omission in this manual, even if advised of the possibility of such damages. In the interest of continued product development, Hach Lange reserves the right to make improvements in this manual and the products it describes at any time, without notice or obligation.



1.2 Safety information

Please read the entire manual before unpacking, setting up, or operating this analyzer.







Pay particular attention to all warning and caution statements. Failure to do so could result in serious injury to the operator or damage to the equipment.

To ensure the protection provided by this equipment is not impaired, do not use or install this equipment in any manner other than that which is specified in this manual.

1.2.1 Use of hazard information

 DANGER	
Indicates a potentially or imminently hazardous situation which, if not avoided, will result in death or serious injury.	
 WARNING	
Indicates a potentially or imminently hazardous situation which, if not avoided, could result in death or serious injury.	
 CAUTION	
Indicates a potentially or imminently hazardous situation that may result in minor or moderate injury.	
NOTICE	
Indicates a situation which, if not avoided, may cause damage to the instrument. Information that requires special emphasis.	

1.2.2 Safety precautions

 DANGER	
	Always remove power from the controller before performing maintenance activities.
 WARNING	
	Potential Electrocution Hazard. Always disconnect power to the instrument when making electrical connections.
 WARNING	
	Potential Electrocution Hazard. If this equipment is used outdoors or in potentially wet locations a Ground Fault Interrupt device must be used for connecting the equipment to its main power source.

 WARNING	
	Potential Electrocution Hazard. Connect only safety low voltage < 33 VAC RMS.

 CAUTION	
Personal Injury Hazard. Only qualified personnel should conduct the tasks described in this manual.	

NOTICE	
Install the device in a location and position that gives easy access to the disconnect device and its operation.	

NOTICE	
	Potential Instrument Damage. Delicate internal electronic components can be damaged by static electricity, resulting in degraded performance or eventual failure.





- ***The power cord plug connection is also used as a main power switch.***
- ***The instrument must be connected to an electrical system which complies with applicable local regulations.***
- ***All the cables connected to the instrument must be fire resistant, type UL94V-1***
- ***The operator must read and understand this manual before using the instrument.***
- ***The instrument will not be used as a safety device. It does not provide a security function in a hazardous process.***





1.2.3 Service and repairs

None of the analyzer's components can be serviced by the user. Only personnel from Hach Lange or its approved representative(s) is (are) authorized to attempt repairs to the system and only components formally approved by the manufacturer should be used. Any attempt at repairing the analyzer in contravention of these principles could cause damage to the analyzer and corporal injury to the person carrying out the repair. It renders the warranty null and void and could compromise the correct working of the analyzer and the electrical integrity or the CE compliance of the analyzer.

1.2.4 Precautionary labels

Read all labels and tags attached to the analyzer. Personal injury or damage to the analyzer could occur if not observed.

	This symbol, when noted on a product, indicates a potential hazard which could cause serious personal injury and/or death. The user should reference this instruction manual for operation and/or safety information.
	This symbol, when noted on a product enclosure or barrier, indicates that a risk of electrical shock and/or electrocution exists and indicates that only individuals qualified to work with hazardous voltages should open the enclosure or remove the barrier.
	This symbol, when noted on the product, indicates that the marked item can be hot and should not be touched without care.
	This symbol, when noted on the product, indicates the presence of devices sensitive to electrostatic discharge and indicates that care must be taken to prevent damage to them.

	<p>This symbol, when noted on the product, identifies a risk of chemical harm and indicates that only individuals qualified and trained to work with chemicals should handle chemicals or perform maintenance on chemical delivery systems associated with the equipment.</p>
	<p>This symbol, if noted on the product, indicates the need for protective eye wear.</p>
	<p>This symbol, when noted on the product, identifies the location of the connection for protective earth (ground).</p>
	<p>Electrical equipment marked with this symbol may not be disposed of in European public disposal systems. In conformity with European local and national regulations, European electrical equipment users must now return old or end-of-life equipment to the manufacturer for disposal at no charge to the user.</p>
	<p>Products marked with this symbol indicates that the product contains toxic or hazardous substances or elements. The number inside the symbol indicates the environmental protection use period in years.</p>

1.2.5 Operating altitude

This instrument is rated for an altitude of 2000 m (6562 ft) maximum. Use of this instrument at an altitude higher than 2000 m can slightly increase the potential for the electrical insulation to break down, which can result in an electric shock hazard. The manufacturer recommends that users with concerns contact technical support.

1.2.6 Intended use of this equipment



This high accuracy ORBISPHERE instrument is designed for the measurement of oxygen, ozone or carbon dioxide, for process and laboratory analysis in applications such as beverage, life sciences, power generation and the electronics industry.

ORBISPHERE 410 analyzers are available as wall or pipe mount, and rack mount versions. The ORBISPHERE 410 uses a patented gas phase (or dissolved gas) ORBISPHERE sensor.

Note: A "Normal sensor" or "Smart Sensor" can be connected to the measurement board. A "Smart sensor" is a sensor with a non-volatile memory which allows storage of parameters (calibration coefficient, dates, etc.). When a smart sensor is connected, these parameters are read by the instrument software. The sensor can be calibrated in the lab and installed on site afterwards.

<p>NOTICE</p>
<p>Use of the instrument outside of the environmental conditions described in Technical specifications on page 13 may cause damage to the instrument but without endangering the user.</p>

1.3 Product recycling information

 	<p>ENGLISH</p> <p>Electrical equipment marked with this symbol may not be disposed of in European public disposal systems after 12 August 2005. In conformity with European local and national regulations (EU Directive 2002/96/EC), European electrical equipment users must now return old or end-of-life equipment to the manufacturer for disposal at no charge to the user.</p> <p>Note: <i>For return for recycling, please contact the equipment manufacturer or supplier for instructions on how to return end-of-life equipment for proper disposal.</i></p>
<p>DEUTSCH</p> <p>Elektrogeräte, die mit diesem Symbol gekennzeichnet sind, dürfen in Europa nach dem 12. August 2005 nicht mehr über die öffentliche Abfallentsorgung entsorgt werden. In Übereinstimmung mit lokalen und nationalen europäischen Bestimmungen (EU-Richtlinie 2002/96/EC), müssen Benutzer von Elektrogeräten in Europa ab diesem Zeitpunkt alte bzw. zu verschrottende Geräte zur Entsorgung kostenfrei an den Hersteller zurückgeben.</p> <p>Hinweis: <i>Bitte wenden Sie sich an den Hersteller bzw. an den Händler, von dem Sie das Gerät bezogen haben, um Informationen zur Rückgabe des Altgeräts zur ordnungsgemäßen Entsorgung zu erhalten.</i></p>	
<p>FRANCAIS</p> <p>A partir du 12 août 2005, il est interdit de mettre au rebut le matériel électrique marqué de ce symbole par les voies habituelles de déchetterie publique. Conformément à la réglementation européenne (directive UE 2002/96/EC), les utilisateurs de matériel électrique en Europe doivent désormais retourner le matériel usé ou périmé au fabricant pour élimination, sans frais pour l'utilisateur.</p> <p>Remarque: <i>Veillez vous adresser au fabricant ou au fournisseur du matériel pour les instructions de retour du matériel usé ou périmé aux fins d'élimination conforme.</i></p>	
<p>ITALIANO</p> <p>Le apparecchiature elettriche con apposto questo simbolo non possono essere smaltite nelle discariche pubbliche europee successivamente al 12 agosto 2005. In conformità alle normative europee locali e nazionali (Direttiva UE 2002/96/EC), gli utilizzatori europei di apparecchiature elettriche devono restituire al produttore le apparecchiature vecchie o a fine vita per lo smaltimento senza alcun costo a carico dell'utilizzatore.</p> <p>Nota: <i>Per conoscere le modalità di restituzione delle apparecchiature a fine vita da riciclare, contattare il produttore o il fornitore dell'apparecchiatura per un corretto smaltimento.</i></p>	
<p>DANSK</p> <p>Elektriske apparater, der er mærket med dette symbol, må ikke bortskaffes i europæiske offentlige affaldssystemer efter den 12. august 2005. I henhold til europæiske lokale og nationale regler (EU-direktiv 2002/96/EF) skal europæiske brugere af elektriske apparater nu returnere gamle eller udtjente apparater til producenten med henblik på bortskaffelse uden omkostninger for brugeren.</p> <p>Bemærk: <i>I forbindelse med returnering til genbrug skal du kontakte producenten eller leverandøren af apparatet for at få instruktioner om, hvordan udtjente apparater bortskaffes korrekt.</i></p>	

SVENSKA

Elektronikutrustning som är märkt med denna symbol kanske inte kan lämnas in på europeiska offentliga sopsstationer efter 2005-08-12. Enligt europeiska lokala och nationella föreskrifter (EU-direktiv 2002/96/EC) måste användare av elektronikutrustning i Europa nu återlämna gammal eller uttrangerad utrustning till tillverkaren för kassering utan kostnad för användaren.

Obs! Om du ska återlämna utrustning för återvinning ska du kontakta tillverkaren av utrustningen eller återförsäljaren för att få anvisningar om hur du återlämnar kasserad utrustning för att den ska bortskaffas på rätt sätt.

ESPAÑOL

A partir del 12 de agosto de 2005, los equipos eléctricos que lleven este símbolo no deberán ser desechados en los puntos limpios europeos. De conformidad con las normativas europeas locales y nacionales (Directiva de la UE 2002/96/EC), a partir de esa fecha, los usuarios europeos de equipos eléctricos deberán devolver los equipos usados u obsoletos al fabricante de los mismos para su reciclado, sin coste alguno para el usuario.

Nota: *Sírvase ponerse en contacto con el fabricante o proveedor de los equipos para solicitar instrucciones sobre cómo devolver los equipos obsoletos para su correcto reciclado.*

NEDERLANDS

Elektrische apparatuur die is voorzien van dit symbool mag na 12 augustus 2005 niet meer worden afgevoerd naar Europese openbare afvalsystemen. Conform Europese lokale en nationale wetgeving (EU-richtlijn 2002/96/EC) dienen gebruikers van elektrische apparaten voortaan hun oude of afgedankte apparatuur kosteloos voor recycling of vernietiging naar de producent terug te brengen.

Nota: *Als u apparatuur voor recycling terugbrengt, moet u contact opnemen met de producent of leverancier voor instructies voor het terugbrengen van de afgedankte apparatuur voor een juiste verwerking.*

POLSKI

Sprzęt elektryczny oznaczony takim symbolem nie może być likwidowany w europejskich systemach utylizacji po dniu 12 sierpnia 2005. Zgodnie z europejskimi, lokalnymi i państwowymi przepisami prawa (Dyrektywa Unii Europejskiej 2002/96/EC), użytkownicy sprzętu elektrycznego w Europie muszą obecnie przekazywać Producentowi stary sprzęt lub sprzęt po okresie użytkowania do bezpłatnej utylizacji.

Uwaga: *Aby przekazać sprzęt do recyklingu, należy zwrócić się do producenta lub dostawcy sprzętu w celu uzyskania instrukcji dotyczących procedur przekazywania do utylizacji sprzętu po okresie użytkowania.*

PORTUGUES

Qualquer equipamento eléctrico que ostente este símbolo não poderá ser eliminado através dos sistemas públicos europeus de tratamento de resíduos sólidos a partir de 12 de Agosto de 2005. De acordo com as normas locais e europeias (Directiva Europeia 2002/96/EC), os utilizadores europeus de equipamentos eléctricos deverão agora devolver os seus equipamentos velhos ou em fim de vida ao produtor para o respectivo tratamento sem quaisquer custos para o utilizador.

Nota: *No que toca à devolução para reciclagem, por favor, contacte o produtor ou fornecedor do equipamento para instruções de devolução de equipamento em fim de vida para a sua correcta eliminação.*

1.4 Product disposal

Note: The following only applies to European customers.

Hach Lange is committed to ensuring that the risk of any environmental damage or pollution caused by any of its products is minimized as far as possible. The European Waste Electrical and Electronic Equipment (WEEE) Directive (2002/96/EC) that came into force on August 13 2005 aims to reduce the waste arising from electrical and electronic equipment; and improve the environmental performance of all those involved in the life cycle of electrical and electronic equipment.



In conformity with European local and national regulations (EU Directive 2002/96/EC stated above), electrical equipment marked with the above symbol may not be disposed of in European public disposal systems after 12 August 2005.

Hach Lange will offer to take back (**free of charge to the customer**) any old, unserviceable or redundant analyzers and systems which carry the above symbol, and which were originally supplied by Hach Lange. Hach Lange will then be responsible for the disposal of this equipment.

In addition, Hach Lange will offer to take back (**at cost to the customer**) any old, unserviceable or redundant analyzers and systems which do not carry the above symbol, but which were originally supplied by Hach Lange. Hach Lange will then be responsible for the disposal of this equipment.

Should you wish to arrange for the disposal of any piece of equipment originally supplied by Hach Lange, please contact your supplier or our After Sales Service department in Geneva for instructions on how to return this equipment for proper disposal.

1.5 Restriction of hazardous substances (RoHS)

Dieses Informationsblatt enthält Angaben, die ausschließlich für den Export dieses Gerätes in die Volksrepublik China erforderlich sind.

This document contains information which is only required for the export of this instrument into the People's Republic of China.

Ce document contient les informations nécessaires pour l'exportation d'instruments vers la République Populaire de Chine.

本手册包含的必要信息只适用于出口到中华人民共和国的仪器。

Type: 410/51x

Name: Controller

部件名称 (Parts)	有毒有害物质或元素 (Hazardous Substance)					
	铅 (Pb)	汞 (Hg)	镉 (Cd)	六价铬 (Cr6+)	多溴联苯 (PBB)	多溴二苯醚 (PBDE)
二极管 (Diode)	X	O	O	O	O	O
连接器 (Connector)	X	O	O	O	O	O
坚果 (Nut)	X	O	O	O	O	O





O:	表示该部件的有毒有害物质在所有均质材料中的含量均为 SJ/T11363-2006 标准规定的限量要求以下 Indicates that the concentration of the hazardous substance in all homogeneous materials in the parts is below the relevant threshold of the SJ/T11363-2006 standard.
X:	表示该部件的有毒有害物质至少在某一均质材料中的含量超出 SJ/T11363-2006 标准规定的限量要求 Indicates that the concentration of the hazardous substance of at least one of all homogeneous materials in the parts is above the threshold of the SJ/T11363-2006 standard.
<p>对销售之日的所售产品，本表显示，朗讯供应链的电子信息产品可能包含这些物质。注意：在所售产品中可能会也可能不会含有所有所列的部件</p> <p>This table shows where these substances may be found in the supply chain of "Company" electronic information products, as of the date of sale of the enclosed product. Note that some of the component types listed above may or may not be a part of the enclosed product.</p>	

	<p>除非另外特别的标注，此标志为针对所涉及产品的环保使用期标志。某些可更换的零部件会有一个不同的环保使用期（例如，电池单元模块）贴在其产品上。此环保使用期限只适用于产品的手册中所规定的条件下工作。</p> <p>The Environmentally Friendly Use Period (EFUP) for all enclosed products and their parts are per the symbol shown here, unless otherwise marked. Certain field-replaceable parts have a different EFUP (for example, battery modules) and so are marked to reflect such. The Environmentally Friendly Use Period is valid only when the product is operated under the conditions defined in the product manual.</p>
---	--



Section 2 Specifications

Specifications are subject to change without notice.

2.1 Technical specifications

OPERATING CONDITIONS	
Operating temperature limits	-5 to 50°C (23 to 122 °F)
Storage temperature limits	-20 to 70°C (-4 to 158 °F)
Operating humidity limits	0 to 95% non condensing relative humidity
Operating altitude	From 0 to 2,000 m. (6,550 ft.) above sea level
EMC requirements	EN61326-1: EMC Directive Note: <i>The wall mount instrument is a Class A product. In a domestic environment this product may cause radio interference in which case the user may be required to take adequate measures.</i>
 Korean registration	User Guidance for EMC Class A Equipment 업무용을 위한 EMC 등급 A 장치에 대한 사용자 지침 사용자안내문 A 급 기기 (업무용 방송통신기자재) 이 기기는 업무용 (A 급) 전자파적합 기기로서 판매자 또는 사용자는 이 점을 주의하시기 바라며 , 가정외의 지역에서 사용하는 것을 목적으로 합니다 .
CE compliance	EN61010-1: LVD Directive
Safety rating	ETL, conforming to UL 61010-1 and CSA 22.2 No. 61010-1
Enclosure ratings	IP 65 Totally protected against dust. Protected against low pressure jets of water from all directions. NEMA4X (wall mount only) Totally protected against dust. Protected against pressure jets of water from all directions.
	 WARNING
	 Enclosure rating does not apply to external power supply for benchtop instruments.
POWER SUPPLY	
Power supply	Universal 100 VAC to 240 VAC @ 50/60Hz - 40VA 10 to 30 VDC - 30W
ANALOG OUTPUTS	
Analog current output version on the measurement board	4-20 mA (default) or 0-20 mA (configuration with software) 3 configurable outputs Maximum load: 500 ohm Sensitivity: 20µA Accuracy: ± 0.5% (between operating temperature limits)
Analog voltage output version on the measurement board	0- 5 V output (hardware option) 3 configurable outputs Minimum load: 10 KOhm Sensitivity: 5 mV Accuracy: ± 0.5% (between operating temperature limits)
DIGITAL OUTPUTS	
Measurement alarm relays on the measurement board	Three alarm relays 1A-30 VAC or 0.5A-50 VDC on a resistance load Configurable to Normally Open [NO] or Normally Closed [NC] contacts by changing the jumper positions.
	 WARNING
	 Potential Electrocution Hazard. Connect only safety low voltage < 33 VAC RMS.

Specifications

System alarm relay on the main board	One "instrument system alarm" relay per instrument 1A-30 VAC or 0.5A-50 VDC on a resistance load Normally closed [NC] (NO relay also available) when instrument is turned on. Opens when a system alarm is detected, and when it does not receive any signal.
	 WARNING
	 Potential Electrocution Hazard. Connect only safety low voltage < 33 VAC RMS.
COMMUNICATION	
Options	RS-485 or PROFIBUS-DP (optional); USB host ; Ethernet 10/100 Base-T
GENERAL	
Thermal cut off	Prevents ageing of sensors when exposed to high temperatures
SIZE AND WEIGHT	
Wall and pipe mount (H x D x W)	236.5 x 160 x 250 mm - weight 4.25 kg 9.31 x 6.30 x 9.84 in. - weight 8.82 lbs
Panel mount: Face (housing) (H x D x W)	156 (123) x 250 x 220 (214) mm - weight 3.35 kg 6.14 (4.84) x 9.84 x 8.86 (8.43) in. - weight 6.62 lbs

2.2 Hardware description

The instrument hardware is made of one main board, and one measurement board for the measurement channel (= the sensor).

The main board includes the controls for power, display, the touch screen, the barometric sensor, the alarms, and communication ports. The measurement board performs measurements and executes commands from the main board. It holds the "Analog output" and "Relays" that send information to external systems.

A hardware watchdog is activated at program start up, to check that the system is not frozen (i.e. infinite loop, system crash, etc.). If the watchdog is not refreshed by the software every minute, the measurement display, the relays and the analog output are frozen up to 2 minutes. Then the reset shuts down the instrument for 10 seconds and the start-up procedure is performed. At the same time all the hardware (sensor, measurement board) are reset.

2.3 Model identification system

The analyzer identification number and the instrument serial number are located on the label on the back panel, and can be found on order confirmation and invoice papers.

A	Oxygen EC sensor
C	Ozone EC sensor
D	Carbon dioxide TC sensor
W	Wall
P	Panel
1	100-240 VAC
2	10-30 VDC
C	0/4-20 mA
V	0-5 V
0	RS-485
1	PROFIBUS-DP / RS-485
0	Standard
K	Korean language

4	1	0	/		/					0	0	0	
---	---	---	---	--	---	--	--	--	--	---	---	---	--

Example: 410 / A / W1C0 0000

- Analyzer model 410
- For oxygen measurement
- Wall mounted
- 100-240 VAC
- 0/4 20 mA analog output
- RS-485
- Standard software (English, French, German, Italian, Spanish, Russian, Japanese, Chinese)

2.4 Security level table

A cross means that the user who has this user security level can access this function or setting. Refer to [User management on page 80](#).

Note: When not shown, the sub-levels carry the same security level as the level above.

Main	0	1	2	3	4
View	X	X	X	X	X
Measurement	X	X	X	X	X
Calibration			X	X	X
Inputs/outputs			X	X	X
Communication			X	X	
Security			X	X	
Products			X	X	X
Global config			X	X	
Services			X	X	X

View	0	1	2	3	4
Numeric	X	X	X	X	X
Graphic	X	X	X	X	X
Statistical	X	X	X	X	X
Event	X	X	X	X	X
Diagnostic	X	X	X	X	X
Configure			X	X	

Measurement	0	1	2	3	4
Config instrument				X	X
Config channel				X	X
Measurement file				X	X

Calibration	0	1	2	3	4
Gas sensor			X	X	X
Interferences			X	X	X
Barometer			X	X	
External pressure			X	X	
Amplifiers				X	
Reports			X	X	X

Inputs/Outputs	0	1	2	3	4
Snooze				X	X
View			X	X	X
Relays			X	X	
Analog outputs			X	X	

Communication	0	1	2	3	4
RS 485				X	X
RS 485 simple				X	X
Profibus DP				X	X
USB-A				X	X
HTTP / TCP/IP				X	X

Security	0	1	2	3	4
Configuration					X
Access table					X
View log file					X

Products	0	1	2	3	4
Select product			X	X	X
Modify product			X	X	

Global config	0	1	2	3	4
Save config				X	X
Select config				X	X

Services	0	1	2	3	4
Diagnostic				X	X
Language				X	X
Clock				X	X
Screen				X	X
Buzzer				X	X
Boards info				X	X
Batteries				X	X
Soft download				X	
More				X	

Diagram Legend:					
Security level :	0	1	2	3	4
Available			X	X	X
Optional				X	X
Not available					X

Gas sensor	0	1	2	3	4
Calibration			X	X	X
Verification			X	X	X
Configuration				X	X
Reports			X	X	X

Reports	0	1	2	3	4
Sensor			X	X	X
Interferences			X	X	X
Barometer			X	X	X

Note: For the USB-A option in the Communication Menu, level 4 access is required to import the access table data.











2.5 Default parameters

The table below indicates the factory default configurations. The instrument has these settings when started for the first time.

Parameter	Default settings	Customer settings
Security	Disabled	
Measurement		
Measurement mode	Continuous	
Data filter	Disabled	
Sample phase	Liquid	
Units	ppm-ppb	
Display resolution	XX.X	
Storage mode	Rolling buffer	
Sensor Membrane	2956	
Temp unit	°C	
Pressure unit	bar	
Calibration		
Mode	in air (O ₂ , O ₃)	
Hold	Enabled	
Analog outputs		
Range	4-20 mA (0-5V)	
Output	Gas measurement	
Extended mode	Disabled	
Characteristics	Linear mode	
Alarm relays	Disabled	
Thermal cutoff	Enabled	
Thermal cutoff temp	65°C	
Calibration timer	Disabled	
Service timer	Disabled	
Buzzer		
Screen tap	Enabled	
Alarm sound	Disabled	
Display		
Minigraph	Enabled	
Temperature	Disabled	

Section 3 Installation

This section provides necessary information to install and connect the analyzer. The installation of the analyzer should be performed in accordance with relevant local regulations.

 DANGER	
	Electrocution Hazard. Do not connect AC power to a 5 VDC powered model.
 WARNING	
	Potential Electrocution Hazard. Always disconnect power to the instrument when making electrical connections.
 WARNING	
	Potential Electrocution Hazard. If this equipment is used outdoors or in potentially wet locations a Ground Fault Interrupt device must be used for connecting the equipment to its main power source.
 WARNING	
	Potential Electrocution Hazard. A protective earth (PE) ground connection is required for both 100-240 VAC and 5 VDC wiring applications. Failure to connect a good PE ground connection can result in shock hazards and poor performance due to electromagnetic interferences. ALWAYS connect a good PE ground to the controller terminal.
 CAUTION	
Personal Injury Hazard. Only qualified personnel should conduct the tasks described in this section of the manual.	
NOTICE	
Install the device in a location and position that gives easy access to the disconnect device and its operation.	
NOTICE	
	Potential Instrument Damage. Delicate internal electronic components can be damaged by static electricity, resulting in degraded performance or eventual failure.

3.1 Unpacking

Remove carefully the instrument and its accessories from the box and packing material, referring to the packing list included to confirm that everything has been delivered.

Please visually inspect the instrument for shipping damage. If anything is missing or damaged, contact the manufacturer or your dealer immediately.

You may want to retain the box and other packing material in case later you need to ship the instrument. Refer to [Storage, handling and transportation on page 92](#). Please dispose safely and ecologically of the box and packing material (if not stored for future use).

Please read through this manual thoroughly before carrying out the installation.

3.2 Installation check list

To complete the installation, proceed to the following actions:

1. Follow the installation instructions in this section carefully
2. On completion, verify once more that everything is properly connected
3. Turn the instrument on
4. Set the language
5. Set the security levels, users ID's and passwords
6. Perform a barometric sensor calibration
7. Perform the gas sensor(s) calibration
8. Perform calibration for the interferences
9. Adjust the settings for correction factors and interferences

The instrument should now be ready for operation. If a problem occurs, refer to [Troubleshooting on page 91](#). If the difficulty cannot be overcome, please contact your Hach Lange representative who will be happy to assist you.

3.3 Wall mount and pipe mount instruments

3.3.1 Instrument dimensions

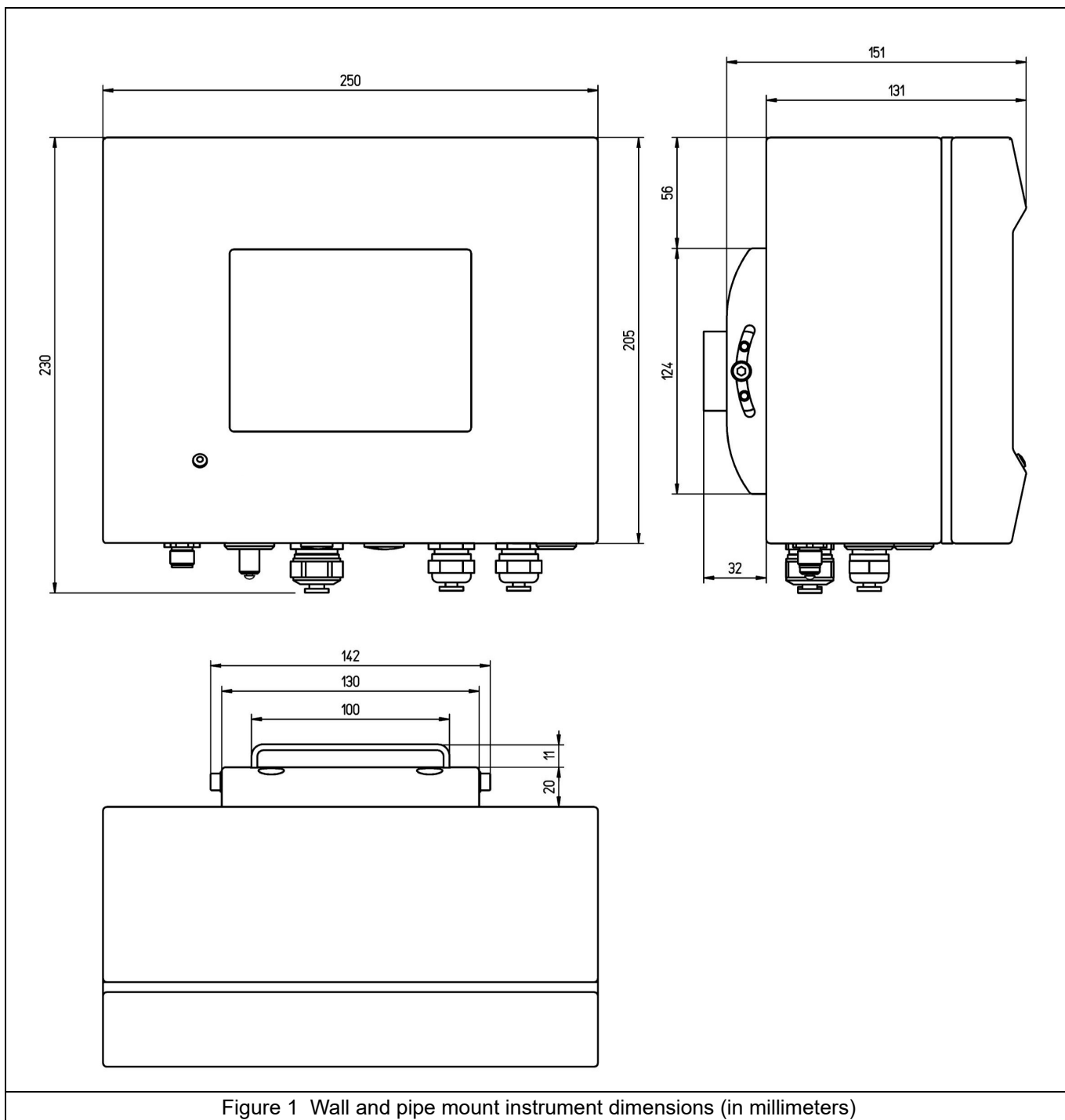
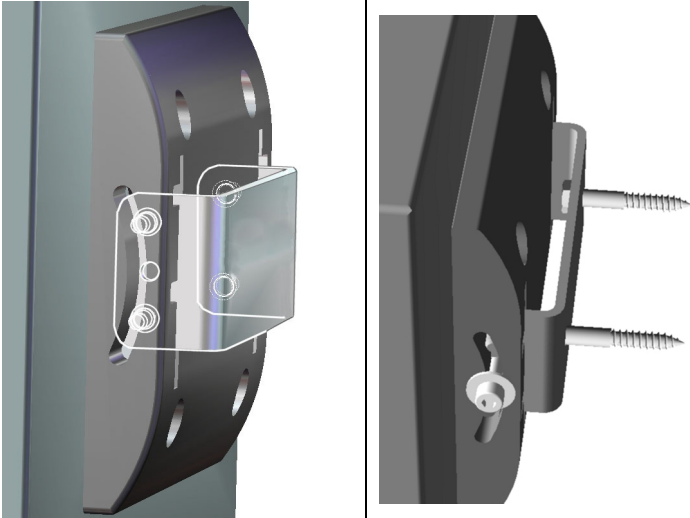

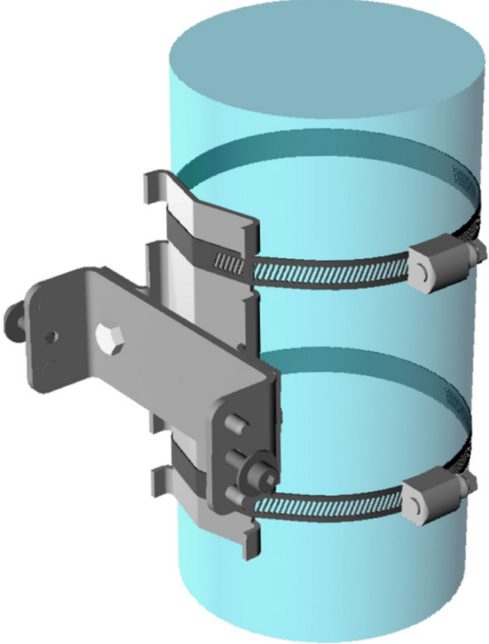



Figure 1 Wall and pipe mount instrument dimensions (in millimeters)

3.3.2 Wall mounting

		<p>Attach the U bracket provided to the wall with two screws (not provided).</p>  <p>Tilt the instrument slightly backwards to align the bracket pins and the insertion slots, and slide the instrument onto the bracket as shown.</p> <p>Insert the 2 locking screws with washers through the side slots.</p> <p>Adjust instrument angle for better screen vision, and lock both side screws.</p>
<p>Figure 2 Wall mount bracket</p>		

3.3.3 Pipe mounting

	<p>Assemble the pipe mount bracket to the U-bracket, using the two screws provided</p>  <p>Attach this assembly to the pipe using two clamps (not provided) as shown on the left</p> <p>The rest of the procedure is similar to the wall mount version, pictured above.</p> <p>Slide the instrument onto the bracket.</p> <p>Insert the 2 locking screws with washers through the side slots.</p> <p>Adjust the instrument angle for better screen vision, and lock both side screws.</p>
<p>Figure 3 Pipe mount diagram</p>	

3.3.4 Connection panel (bottom of instrument)

Front panel door

A square key is provided to open the instrument front panel locks. The two locks are located on the right side of the instrument on the top and bottom panels (number 8 in [Figure 4](#) below).

The front panel can be easily pivoted to the left as shown below. To retain the instrument waterproof tightness, make sure the seal is clean and in good condition before closing the front panel.

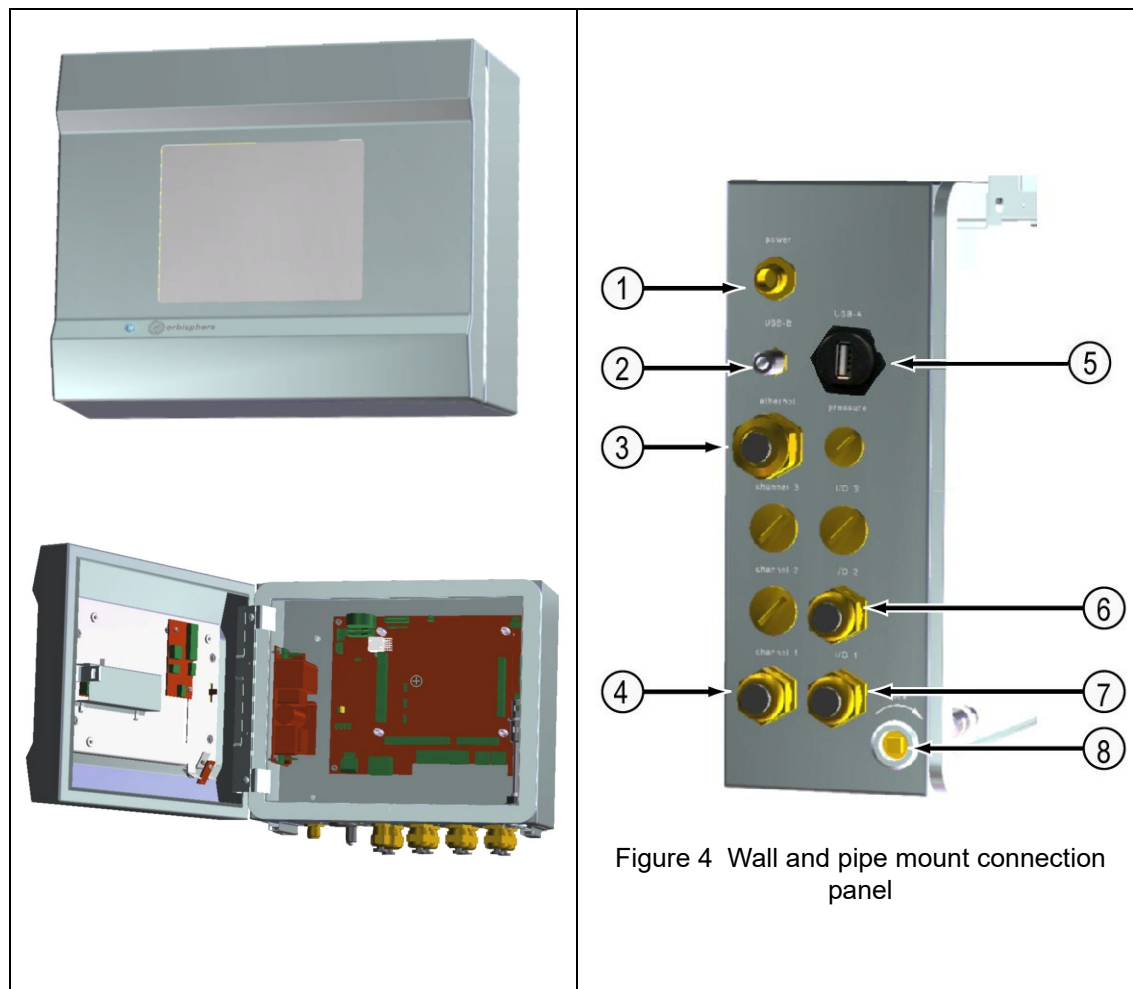

Figure 4 Wall and pipe mount connection panel

<ol style="list-style-type: none"> 1. Power cable. The type of connection will vary depending on the instrument specification. Refer to Connection to mains power supply on page 26. 2. USB-B 4 pin connector (reserved for manufacturing) 3. Ethernet cable gland 	<ol style="list-style-type: none"> 4. Sensor cable gland 5. USB-A host connector for mass storage device 6. Input/Output 2 cable gland 7. Input/Output 1 cable gland 8. Keylock (bottom panel)
---	---

3.4 Panel mount instrument

3.4.1 Instrument dimensions

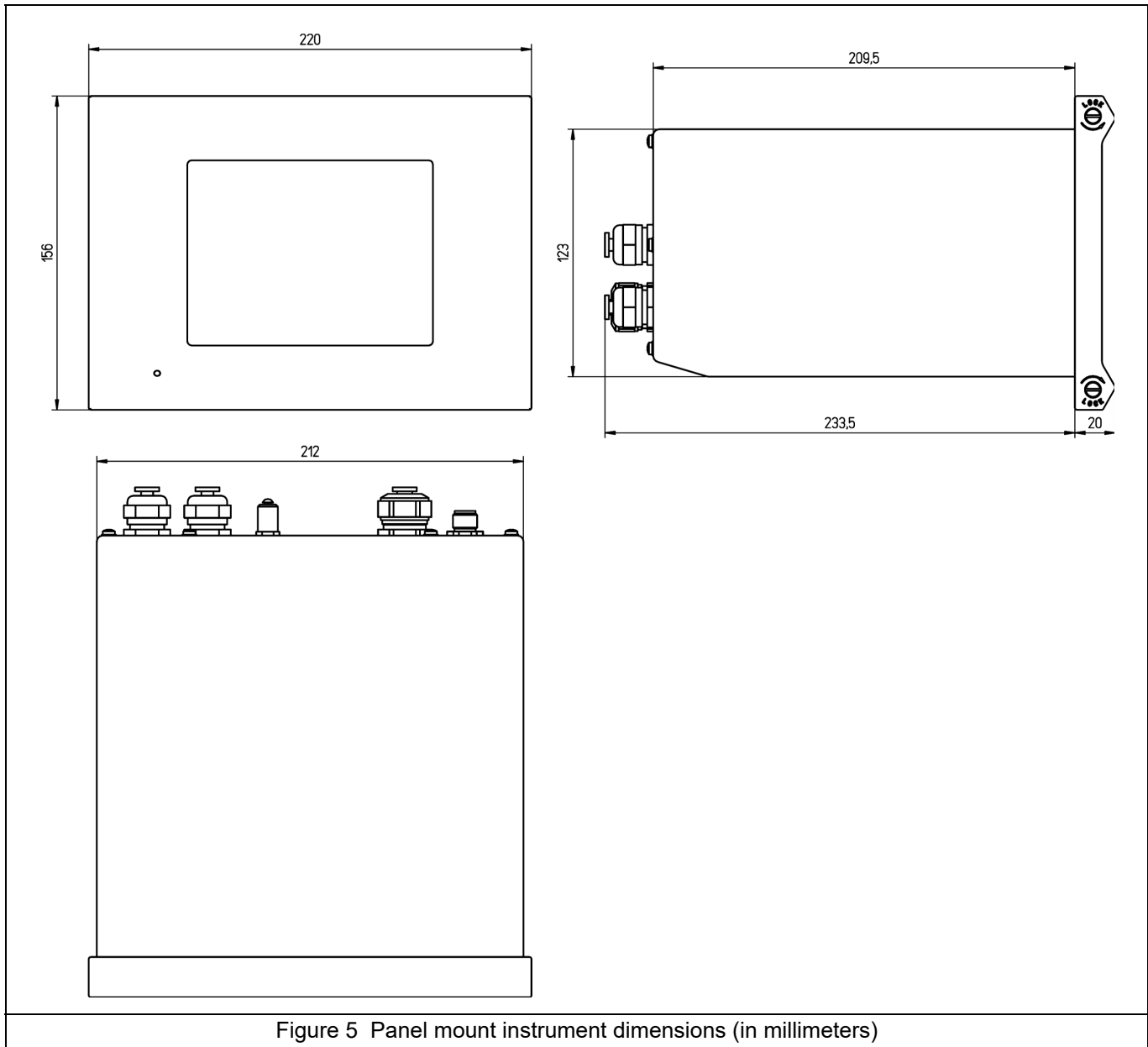

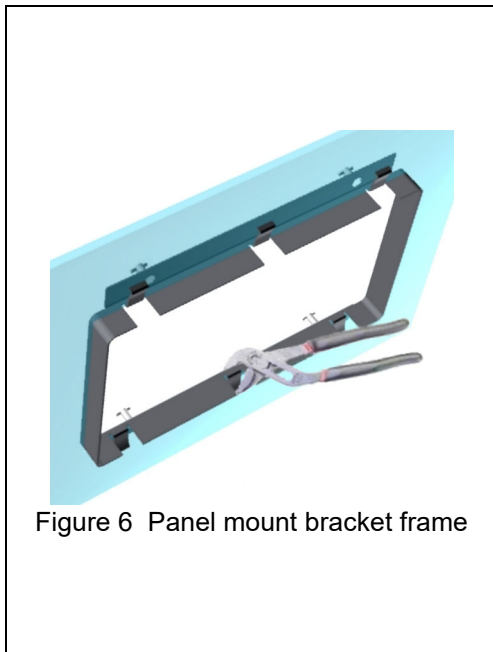

Figure 5 Panel mount instrument dimensions (in millimeters)

3.4.2 Mounting

⚠ WARNING

 Electrocuting hazard. If the cable and connector for the power supply are not accessible after installation, an accessible local disconnection means for the instrument power is mandatory.



1. Cut an opening in the panel to accommodate the bracket frame provided (this is the same size as previous generations of ORBISPHERE type 3600 instruments).

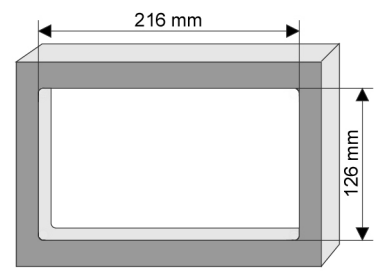

2. Install the provided frame in the opening
3. Fold the 6 tabs over the panel lips, using adjustable joint pliers.

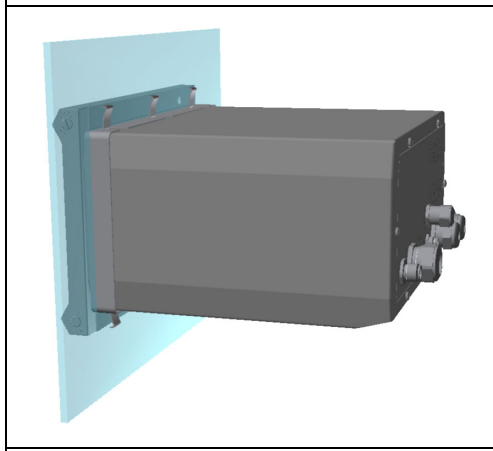

4. Slide the instrument in the bracket frame. The instrument should go over the four "T" pins. Rotate the 4 fast locking screws on both sides of the front panel and slide it in.
5. Rotate the 4 fast locking screws 1/4 turn twice in the lock direction as indicated on the side of the front panel. This locks the instrument in place on the four "T" pins.

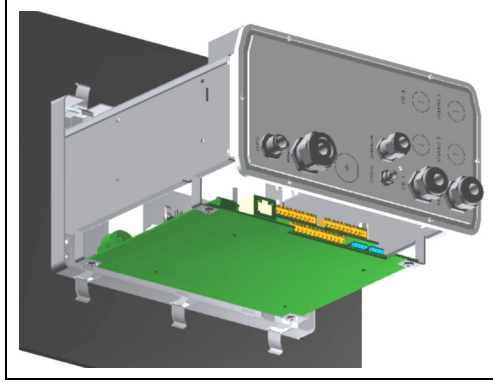

6. To access the connections inside the instrument, remove the instrument housing (six screws on the back panel, and slide the housing back out)
7. Pass the cables through the housing, then through the cable gland (if applicable) and then perform the connections as detailed below.

Note: Do not forget to pass the cable through the housing before passing it through the cable gland on the back panel.

Alternative instrument mounting procedure

When it is not convenient to work from the back of the panel, the instrument can be connected before fitting in the panel.

1. Install the panel support frame in the panel opening
2. Slip the cables through the panel opening
3. Remove the instrument cover
4. Slip the cables through the instrument cover
5. Slip the cables through the instrument back panel cable glands
6. Connect the cables to the instrument electronic boards
7. Tighten the cable glands
8. Reinstall the instrument cover
9. Install the instrument in the panel opening

3.4.3 Connection panel (bottom of instrument)

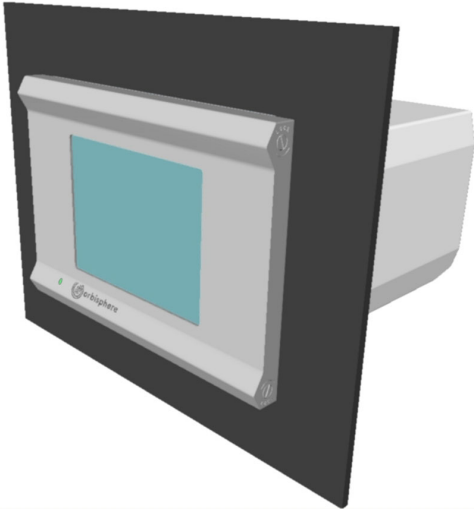
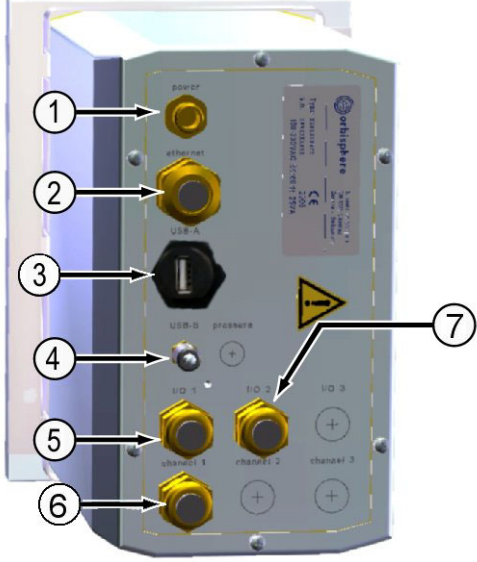
	
<ol style="list-style-type: none"> 1. Power cable. The type of connection will vary depending on the instrument specification. Refer to Connection to mains power supply on page 26. 2. Ethernet cable gland 3. USB-A host connector for mass storage device 	<ol style="list-style-type: none"> 4. USB-B 4 pin connector (reserved for manufacturing) 5. Input/Output 1 cable gland 6. Sensor cable gland 7. Input/Output 2 cable gland
<p>Figure 8 Panel mount connection panel</p>	

3.5 Connectors assembly instructions

⚠ WARNING	
	Potential Electrocutation Hazard. In order to maintain the NEMA/IP environmental ratings of the enclosure, use only conduit fittings and cable glands rated for at least NEMA 4X/IP65 to route cables into the instrument.

3.5.1 Cable gland wiring instructions

A waterproof cable gland is provided each time a cable must be connected inside the instrument. The nickel-plated brass cable glands are EMC-types, designed so that the cable shields attach directly to the instrument housing as a ground. Typical cable wiring instructions are detailed below.

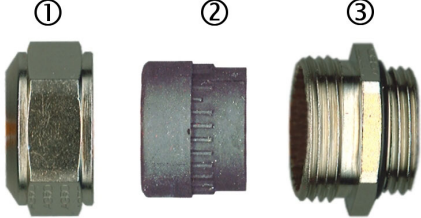
	<p>Gland parts (washers not shown):</p> <ol style="list-style-type: none"> 1. Nut 2. Rubber gasket (seal) 3. Gland fitting with O-ring (attached to instrument housing)
---	--

1. Unscrew the cable gland nut. Inside, the assembly is composed of a rubber gasket, and two metal washers. Note that the ethernet gland on panel and wall mount instruments does not have washers and the gasket is cut.
2. If wiring a sensor cable, the cable has already been prepared so simply remove the piece of plastic protection from the exposed shielding. For other cables, strip off external insulation as required, and 25 mm of shielding. Strip the wires about 8 mm from their ends (see illustration below).

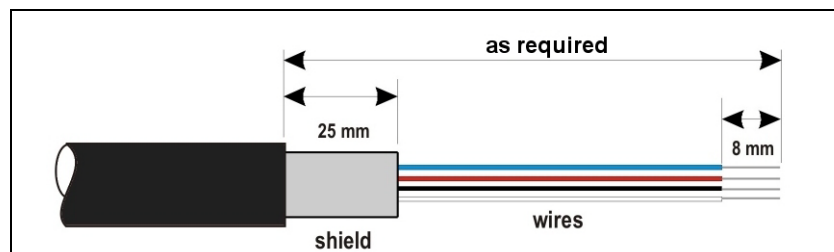

3. Pass the cable through the nut, the rubber gasket, and the two washers
4. Pinch the shield so that its entire circumference is pressed between the two washers and pass the cable into the housing, blocking the cable gland

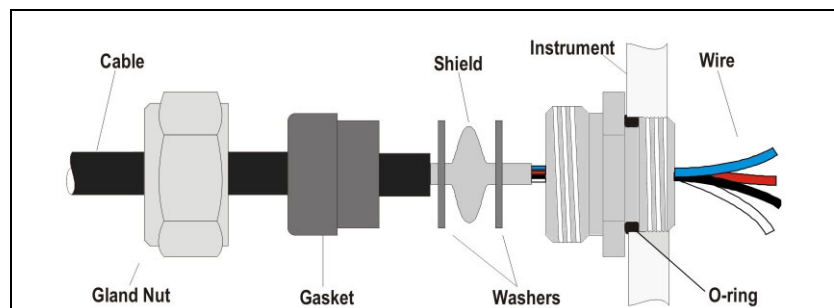

NOTICE
It is vitally important to ensure the shielding is pinched and secured between the two washers to ensure the shielding attaches directly to the instrument housing as a ground. Failure to do this could cause damage to the instrument, and for sensor cables give incorrect readings.

5. Reattach and tighten the cable gland nut
6. Attach the wires to the corresponding terminal block connections

3.6 Connection to mains power supply

3.6.1 Power supply connection (low voltage instruments)

For low voltage instruments (10-30 VDC), connection to the mains power supply is with a 7-pin BINDER connector (supplied).

Note: The connectors are grooved to avoid an incorrect fitting to the instrument.

Connect the power cable to the connector as follows:

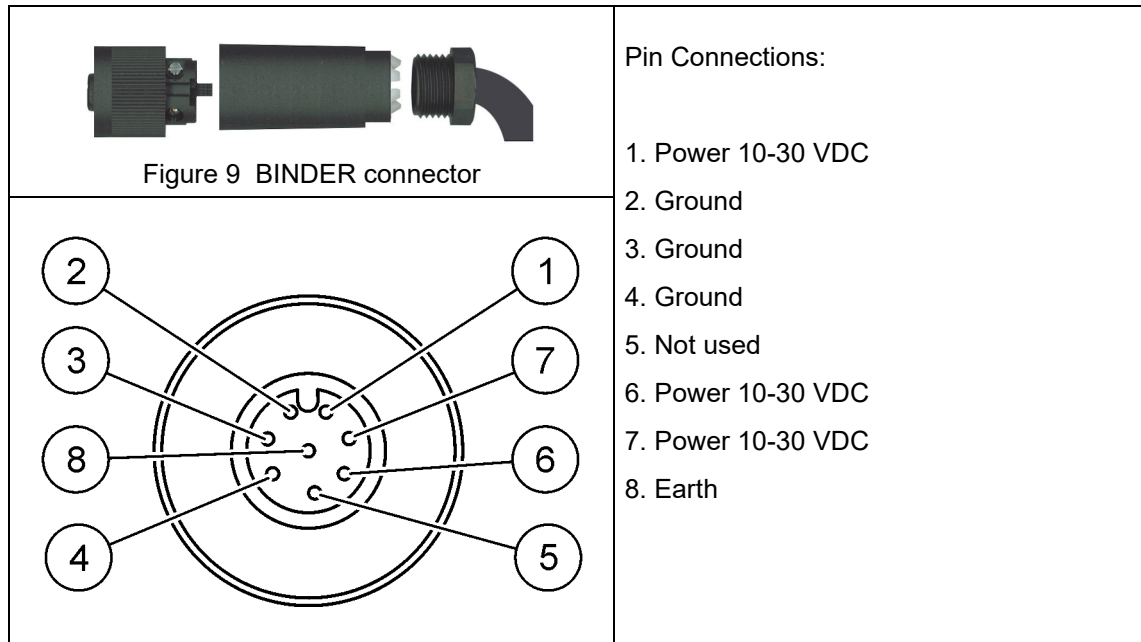

3.6.2 Power supply connection (high voltage instruments)

High voltage instruments (100-240 VAC) have a 4-pin male connector pre-wired internally with a male BINDER connector ready for mains connection. A compatible female connector is supplied with the instrument.

If this female connector was supplied with a mains power plug already pre-attached (cable part numbers 33031, 33032, 33033 and 33034) then the female connector can be plugged directly into the instrument power connector. The two connectors are grooved to avoid an incorrect fitting. Tighten the female connector to the instrument power connector finger-tight.

If no power cable was ordered with the equipment, a mains power plug must be connected to the supplied female connector as described in the following procedure.

CAUTION

Personal Injury Hazard. Only qualified personnel should conduct the tasks described in this section of the manual.

User-supplied power cable specifications:

- 3-wire (live, neutral and earth)
- cable $\varnothing \geq 7\text{mm}$; $\leq 9.5\text{mm}$
- wire selection $\geq 1\text{mm}^2$, AWG18; $\leq 2.5\text{mm}^2$, AWG14

WARNING



Potential Electrocutation Hazard. Always disconnect power to the instrument when making electrical connections.

Prepare the user-supplied power cable as follows:

Strip off 23 mm (0.9 ins.) of shielding from the power cable. Cut back the live and neutral wires to 15 mm (0.6 ins.) in length but leave the earth wire as is. Then strip off a small amount of external insulation from the three wires as required:

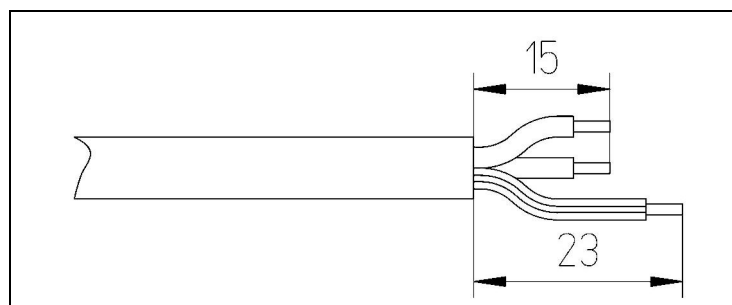

Wire the female connector as follows:

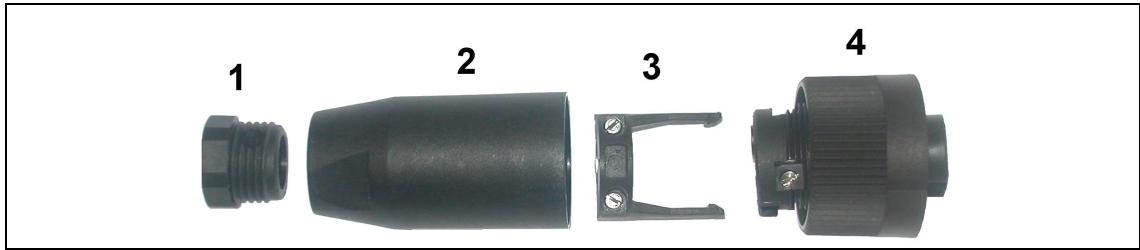

1. Take the narrow end of the connector (4) in one hand and the main body (2) in the other and unscrew the two. Pull away the cable clamp (3) and unscrew the end plug (1) to reveal the four parts that make up the connector.
2. Loosen the screws on the cable clamp (3) to allow enough room to pass the power cable through.
3. Pass the power cable through the end plug (1), the main body (2), and the cable clamp (3), and then connect the three wires (live, neutral and earth) to the connector (4) as follows:

	<p>1) Live (brown) 2) Neutral (blue) 3) Not used</p> <p> Earth (green and yellow)</p>	<p>Note: The numbers and earth symbol are stamped on the end of the connector. Ensure it is connected correctly.</p>
--	---	---

4. Slide the cable clamp (3) back onto the connector (4) and tighten the screws on the clamp to secure the cable.
5. Screw the two parts (4) and (2) back together.
6. Secure the power cable by screwing the end plug (1) back in place.
7. The female connector can now be plugged directly into the instrument power connector. The two connectors are grooved to avoid an incorrect fitting. Tighten the female connector to the instrument power connector finger-tight.

3.7 Connections to electronic boards

NOTICE	
	<p>Potential Instrument Damage. Delicate internal electronic components can be damaged by static electricity, resulting in degraded performance or eventual failure.</p>

Note: Any loose connection wires should be bundled tightly together with the use of nylon cable ties.

3.7.1 Sensor cable

An ORBISPHERE cable is needed to connect the sensor to the instrument. There is a cable gland for cable passage, and the cable must be permanently connected to the measuring board connector. A sensor cable is required with free wires on the instrument end. The free wires are connected to the connector J8 on the measuring board, as detailed later in this chapter.

Instrument	Sensor	Sensor cable
All versions with a cable gland for sensor cable passage	EC	10 wire shielded. Part N° 32501.mm (connector on sensor side only)
Adapter to connect a N°32505 cable (connector on both sides) to the instruments without a Lemo 10 socket on the back panel.	EC	Part N° 32517.mm

3.7.2 Electronic boards connectors

Connectors P8 on the main board, and connectors J7 and J8 on the measurement board are made of two parts. Push down carefully the black levers on either side of the connector and pull it out securely. Perform all connections with these connectors unplugged. Once finished, attach the connectors to the boards by pushing them firmly in place (levers up).

3.7.3 Main board connections

NOTICE

Network and access point security is the responsibility of the customer that uses the wireless instrument. The manufacturer will not be liable for any damages, inclusive however not limited to indirect, special, consequential or incidental damages, that have been caused by a gap in, or breach of network security.

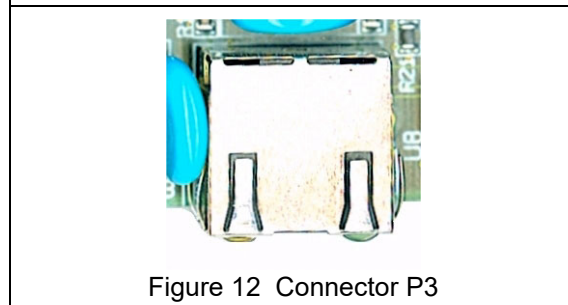
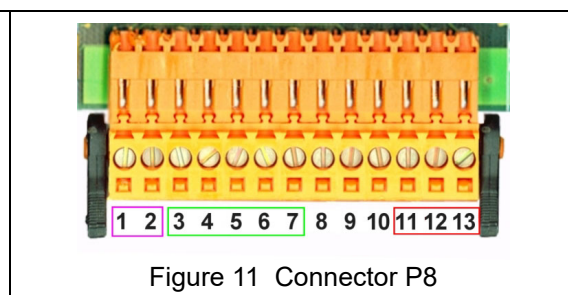
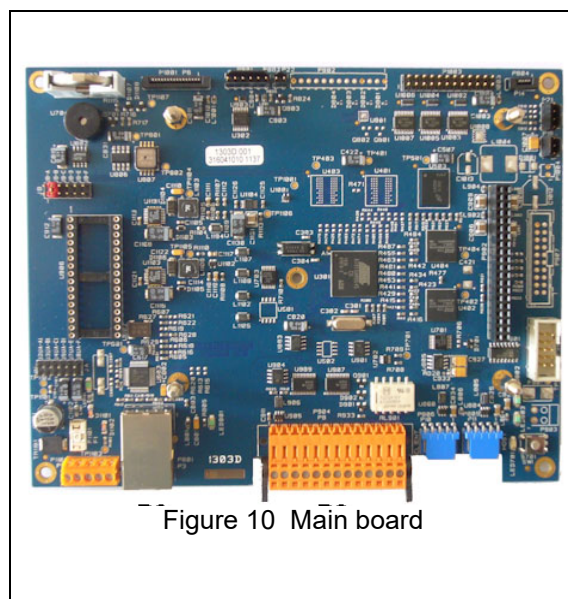

- Connector P8:**
1. RS-485 (signal A)
 2. RS-485 (signal B)
 3. PROFIBUS-DP (GND)
 4. PROFIBUS-DP (+ 5 V)
 5. PROFIBUS-DP (signal -)
 6. PROFIBUS-DP (signal +)

7. PROFIBUS-DP (signal RTS)
8. Not used
9. Not used
10. Not used
11. System alarm relay (N.O.)
12. System alarm relay (N:C.)
13. System alarm relay (Common)

Connector P3
 Ethernet RJ 45. Connect the instrument to the local network by passing an ethernet cable through the ethernet cable gland (location illustrated in [Figure 4 on page 21](#) for the wall mount and [Figure 8 on page 24](#) for the panel mount). Connect to the P3 connector illustrated above.

3.7.4 Measurement board

The different measurement boards for the EC and TC sensors are illustrated in [Figure 13](#) and [Figure 14](#) below. The type of board is easily identified by the color of the J8 connector. For EC boards this connector is colored orange, and for TC boards it is colored black.

NOTICE

It is extremely important that sensors are connected to the correct measurement board. Connecting a TC sensor to an EC measurement board (and vice versa) will cause irreparable damage to the measurement board.

The colors indicated are the wire colors in the sensor cable.

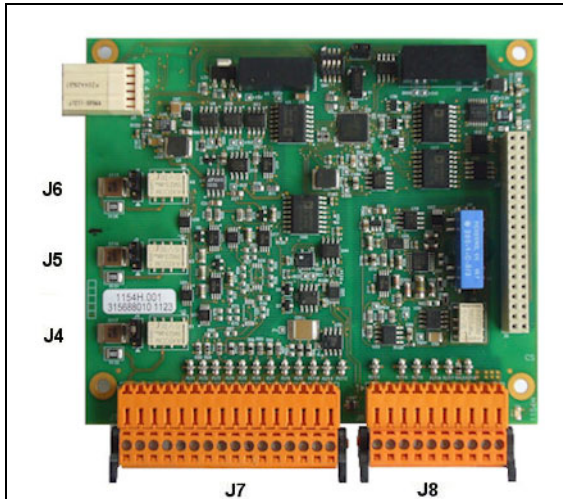

Figure 13 EC Measurement board

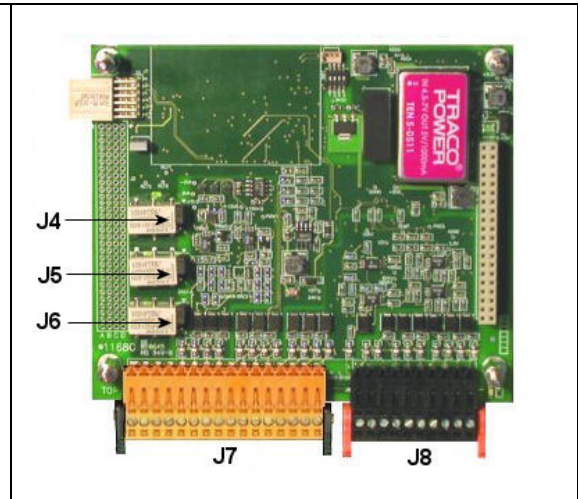

Figure 14 TC Measurement board

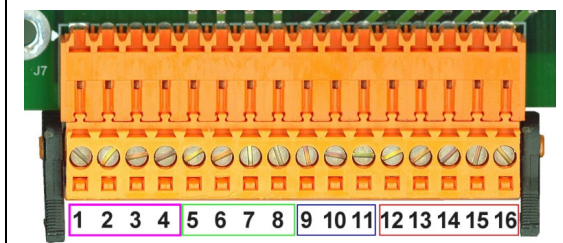

Figure 15 Connector J7

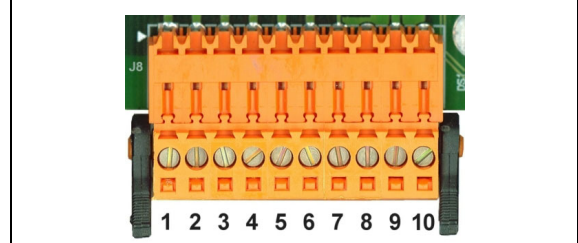

Figure 16 Connector J8

Connector J7 (inputs & outputs)

Measurement alarms relays

1. Common
2. Output relay 1
3. Output relay 2
4. Output relay 3

Note: Relays N.O. or N.C. depends on the jumper position on the relays. Refer to [Measurement alarm relays on page 31](#).

Analog current (or voltage) outputs

5. Analog GND
6. Output 1
7. Output 2
8. Output 3

Digital inputs

9. EC sensor: Not used
TC sensor: Hold input. To deactivate the sensor from a PLC system, connect a dry contact between J7.9 and J7.12
10. Not used
11. Not used
12. Digital GND
13. to 16. Not used

Connector J8 (sensor)					
<i>Note: Remember, this connector is colored orange for EC sensors and black for TC sensors.</i>					
	A1100 EC sensor	31xxx EC sensor	31xxxS smart EC sensor	TC sensor	Cable sensor
1)	Guard electrode	Guard electrode	Guard electrode	GND for power	Yellow
2)	RS485A+	Not used	I2C-SCL	V2 signal	Pink
3)	Thermistor A	Thermistor A	Thermistor A	Solenoid	Grey
4)	Anode electrode	Anode electrode	Anode electrode	Relay coil	Red
5)	RS485B-	Not used	I2C-SDA	+12V power	Purple
6)	Thermistor B	Thermistor B	Thermistor B	+24V power	White
7)	GND	Not used	GND	V3 signal	Black
8)	+ 5V	Not used	+ 5V	GND for signal	Green
9)	Cathode electrode	Cathode electrode	Cathode electrode	-5V power	Blue
10)	Not used	Not used	Not used	Temperature	Brown

Note: To change the type of sensor (e.g. from a 31xxx sensor to a 31xxxS smart sensor) contact your local Hach Lange representative.

3.8 Measurement alarm relays



Figure 17 Output Relays

The three output relays are located on the measurement board (refer to [Figure 13](#) and [Figure 14 on page 30](#)).

They can be individually configured to Normally Open (NO) or to Normally Closed (NC) by physically moving the jumper on each relay. The picture example on the left is for the EC measurement board (the positions are different for the TC measurement board):

- Upper relay is set to NC
- Middle relay is set to NO
- Lower relay is shown with no jumper, to show the 3 pins.

Note: For all measurement boards, J4 is relay 1, J5 is relay 2 and J6 is relay 3

3.9 Sensor installation

3.9.1 EC Sensors

For EC sensor installation, servicing, and maintenance ensure you follow the instructions in the ***Sensor Installation and Maintenance*** manual that was supplied with the instrument.

3.9.2 TC Sensors

For TC sensor installation, servicing and maintenance ensure you follow the instructions in the ***TC Sensor Installation and Maintenance*** manual that was supplied with the instrument. Pay particular attention to the installation and connection of the purge gas supply.

NOTICE

Do not place the TC sensor into a liquid sample until a constant supply of dry purge gas has been connected, as liquid could condense inside the measuring chamber and cause damage to the thermal conductor chip.

To ensure the continuation of purge gas while the sensor is in contact with the sample, it is highly recommended to use a backup purge gas cylinder with an automatic changeover valve that activates when the first cylinder is empty.

The use of an ORBISPHERE Model 29089 gas regulator (or similar) is also recommended to deliver a constant, pressure regulated supply of dry purge gas to the sensor, filtered to 40 µm.

In addition, and to prevent any damage to the sensor electronics, the use of a purge safety backup unit (ORBISPHERE Model 32605) is highly recommended to ensure the supply of purge gas remains uninterrupted to the sensor in the event of a mains power outage.

The above ORBISPHERE accessories are explained in more detail in the ***TC Sensor Installation and Maintenance*** manual.

3.10 Define working language

Refer to [Language selection on page 88](#).

3.11 Define security levels

By default, access rights are disabled meaning no username/password combinations are required to access the instrument menus. Refer to [User management on page 80](#) to set up new users.

Section 4 User Interface

4.1 Instrument

The instrument front panel provides these user interfaces:

- A touch screen acting as display, touch pad and keyboard. Contrast can be adjusted.
- A LED, showing when the instrument is on.
- A buzzer which sounds each time the screen is touched, and when an event alarm is set.

Turning instrument On and Off

There is no power switch on the instrument. The mains must be disconnected to turn the instrument off. The LED indicates when the instrument is on.

Measurement window

The main (numeric) measurement window continuously displays:

- Sensor numeric values
- Measured sensor trends (for the last 10 minutes to last hour)
- Measured sensor data alarm limits and other events
- Temperature

4.2 Touch screen

The user interface on the front panel is a 320x240 pixels display with touch screen. To make navigation user friendly, the interface software is Windows CE based, providing easy selection through menus.

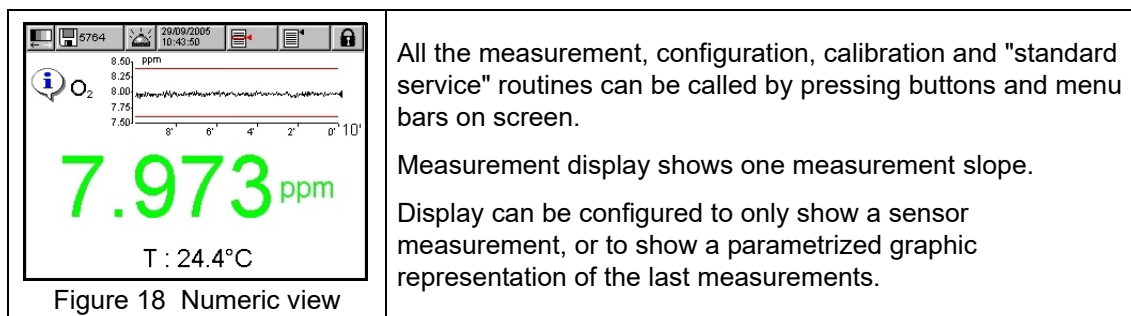



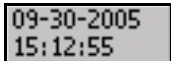
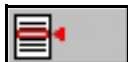



Figure 18 Numeric view

Touching some items on the display calls a related function, similar to a shortcut.

4.2.1 Function keys on the header bar

	<p>Shortcut to the user login window. Pressing this button for more than 2 seconds calls the ID and password window. Refer to Identification and authorization level on page 36.</p> <ul style="list-style-type: none"> • Closed padlock indicates that the touch screen is locked. • Open padlock indicates that the instrument is in view mode only, but no user is logged in (level 0). • When a user is logged in, this box show the authorization level of this user as 1, 2, 3 or 4 (4 being the highest, refer to User management on page 80).
	<p>This icon is used for adjusting the display brightness to improve visibility. It is available all the time to any user, regardless of the user security level. This icon is a shortcut to the backlight adjustment window. Refer to Screen on page 88</p>
	<p>Short cut to the data storage window. Number shows the number of measurement currently stored in volatile memory.</p> <ul style="list-style-type: none"> • No storage • Store at once: When the buffer is full (1,000 positions), the recording of measurement stops. • Rolling buffer: When the buffer is full, the latest measurement set replaces the oldest one (first-in, first-out)
 <p>normal - snooze</p>	<p>In the event of an alarm, the "snooze" button stops the instrument buzzer and returns all the relays in the instrument to their normal state during the "snooze time". The icon indicates if the alarms is on "snooze" or not. This "snooze" is configurable. Refer to Configure security on page 80.</p>
	<p>Current date and time. This is also a shortcut to the date and time setting window.</p>
	<p>Call the contextual menu. This menu is in the header bar and its content is related to the view displayed.</p>
	<p>Opens the main menu page for easy navigation through all available menus.</p>

4.2.2 Menu navigation

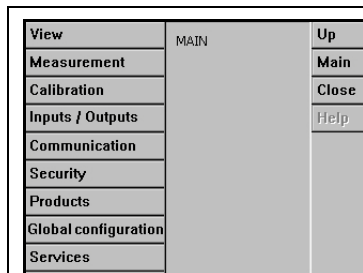

Figure 19 Main menu window

Pressing the “menu” button in the header bar calls the main menu. The display is made of three columns:

- The left column is the menus, or submenus (greyed out options are not available)
- The center column shows a tree view of actual position inside the menu structure
- The right column has the generic controls detailed below.

	Return to previous menu (one step back)
	Jump directly to main menu
	Close the menu and go back to measurement view display. If the menu button is pressed again, the menu returns to its previous state (tree structure is saved)
	Help topics concerning current menu

4.2.3 Rolling list

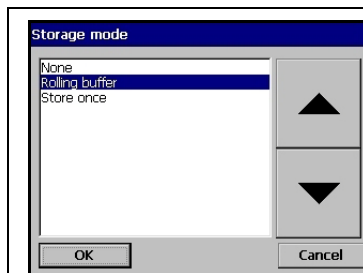

Figure 20 Rolling list example

For convenience, selection through a possible large list of items has been designed with a rolling list, like in this example. Use the up and down arrow to navigate, or select directly one item and press **OK**.

4.2.4 Virtual keyboard

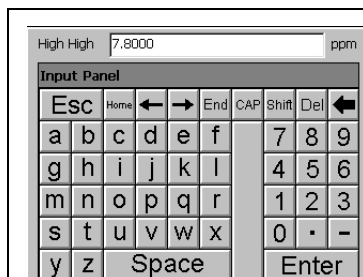

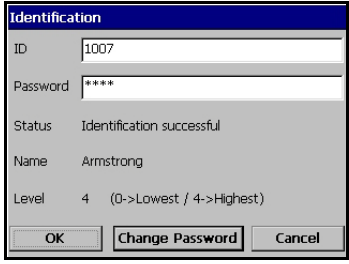

Figure 21 Virtual editing keyboard

When a text box (alphanumeric field) has to be edited and is pressed, a virtual keyboard appears on screen. It can be used as a PC keyboard (pressing CAP gives access to special keys).

Once values have been entered, press the **Enter** key to confirm and exit the virtual keyboard.

During the editing, the edited field name is displayed, along with units where applicable.

4.2.5 Identification and authorization level

 <p>Figure 22 Identification window</p>	<p>Once the access rights have been set, (refer to User management on page 80) it is necessary to log in as an authorized user to get access to the instrument functionalities and settings.</p> <p>Press the closed padlock  for two seconds to open the identification window. The user identification and password must be entered to access functionalities authorized by the security level of the given user (5 levels available. Refer to User management on page 80).</p> <p>For security, when the session inactivity delay period has expired (adjustable, refer to Configure security on page 80), the user is logged off automatically.</p>
--	---

Note: To get to level 0, press the unlock button and OK, without entering any ID or password.

4.2.6 Warning windows

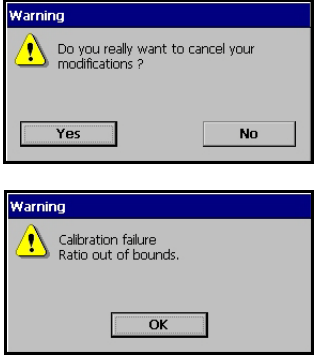
 <p>Figure 23 Warnings</p>	<p>At various stages, a warning message may be displayed to request confirmation from the operator that his last action(s) must really be saved or cleared, or that there is a problem that did not enable the requested action, such as during instrument calibration (example shown left).</p>
--	--

4.3 Main menu structure

This is the structure of the main menu which is used to control every functionality of the instrument. These submenus are detailed in the following sections of this Operator Manual.

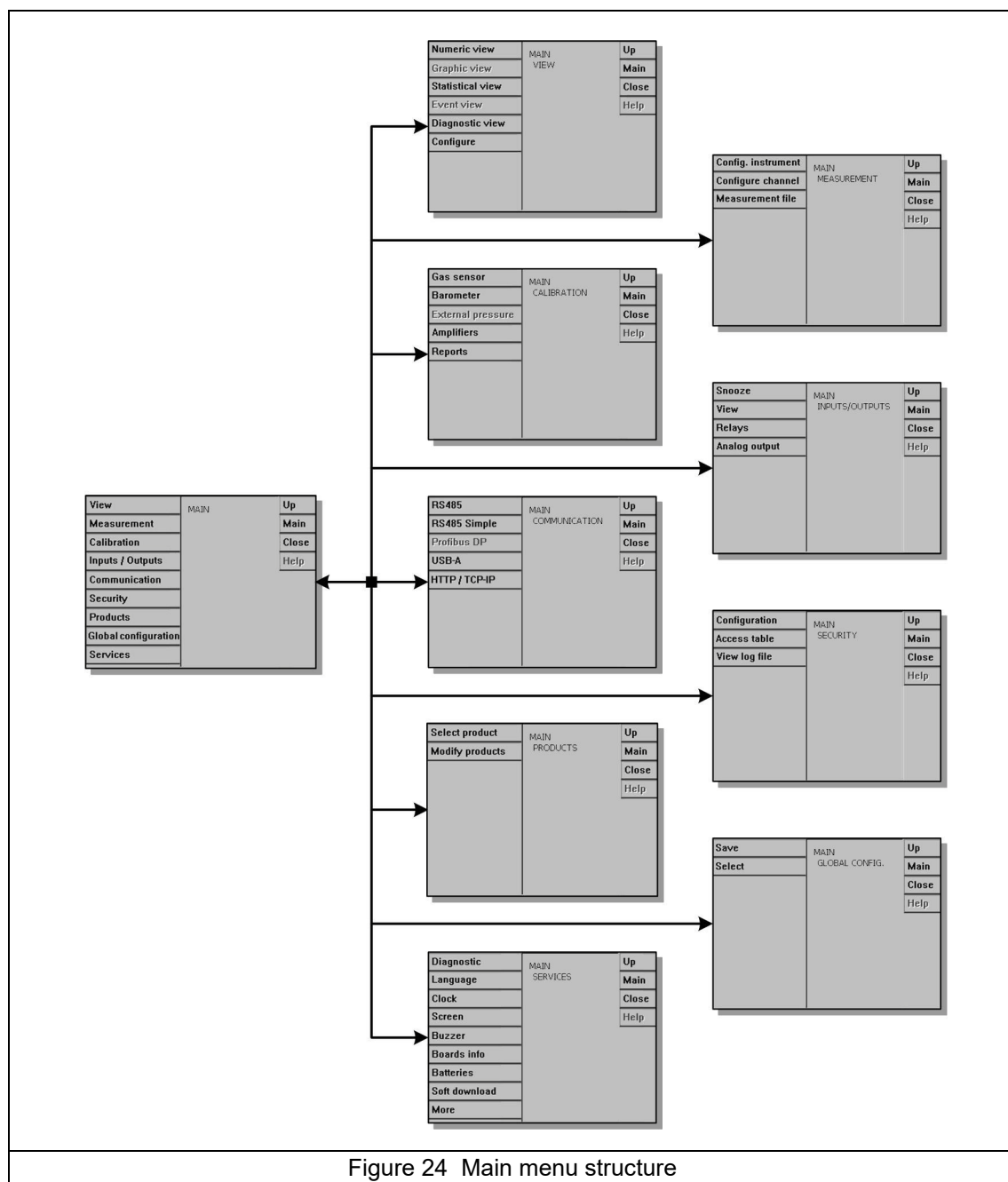

Figure 24 Main menu structure

Section 5 View Menu

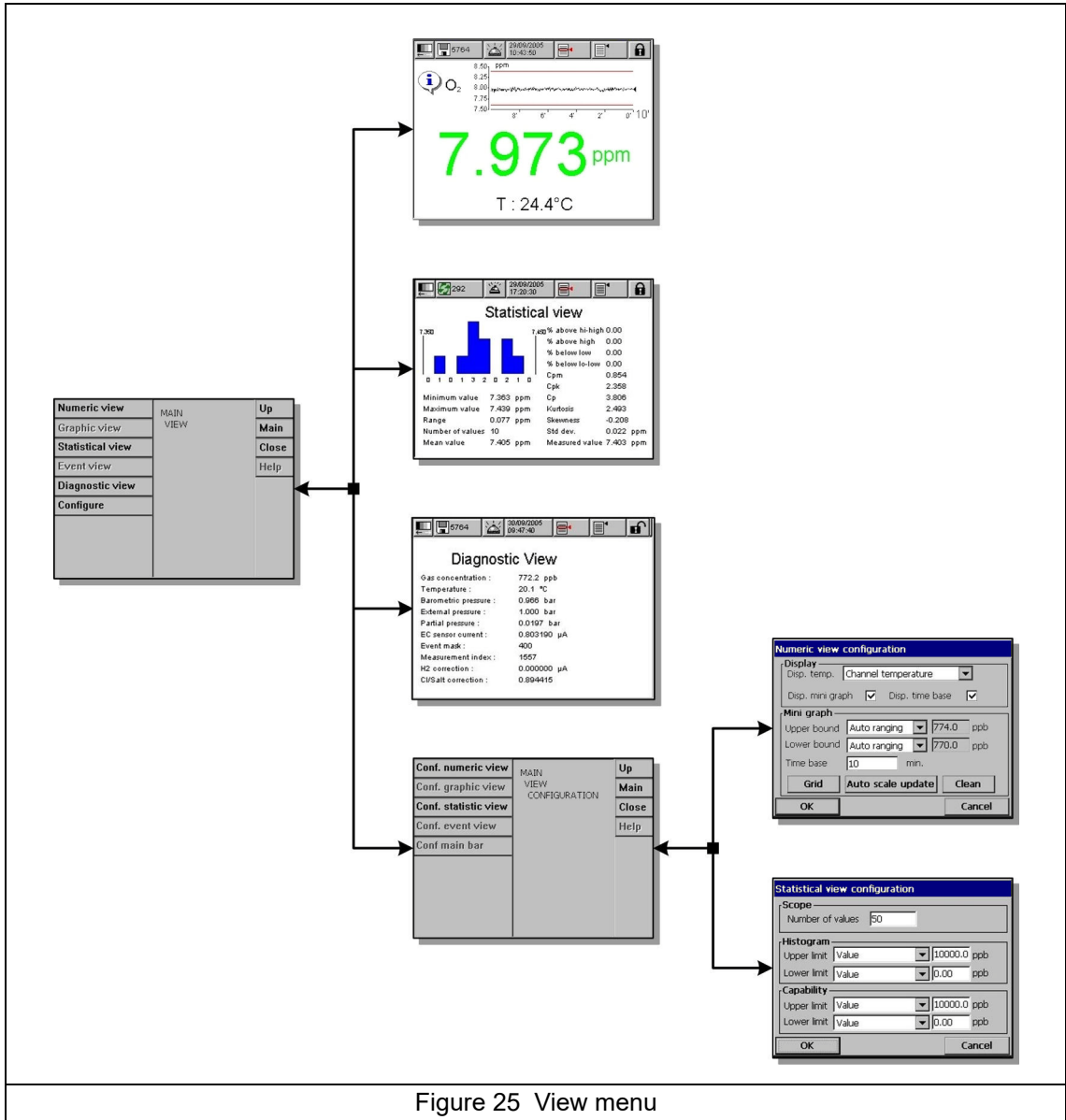

Figure 25 View menu

5.1 Selection of the view style

<p>Numeric view</p> <p>This is the default view. Display shows the numeric measurement value identified for the gas measurement channel, a graphic showing measurement value evolution during the set time frame, and sample temperature.</p> <p>This display can be configured to suit individual conditions and convenience.</p>
<p>Diagnostic view</p> <p>The diagnostic view contains useful information for troubleshooting purposes. The amount of information displayed depends on the gas being measured and the channel configuration.</p>
<p>Statistic view</p> <p>This feature offers statistical data that matches with Total Quality management tools. Statistics is a tool to better analyze how a process behave. The 410 statistics window gives some useful information.</p> <p>The statistics are calculated from the data in the measurement file. The values are updated each time a new value is added to this file. Therefore the changes made in the configuration window are considered only once a new value is added.</p>

<p>Cp process capability</p> <p>Cp is an index used to assess the width of the process spread in comparison to the width of the specification. It is calculated by dividing the allowable spread by the actual spread.</p> <ul style="list-style-type: none"> • A Cp of one indicates that the width of the process and the width of the specification are the same. • A Cp of less than one indicates that the process spread is greater than the specification. This means that some of the data lies outside the specification. • A Cp of greater than one indicates that the process spread is less than the width of the specification. Potentially this means that the process can fit inside the specification limits
--

<p>CPk process variability</p> <p>Cpk takes into account the center of the data relative to the specifications, as well as the variation in the process.</p> <ul style="list-style-type: none"> • A Cpk value of one indicates that the tail of the distribution and the specification are an equal distance from the overall average. • A Cpk of less than one means that some of the data is beyond the specification limit. • A Cpk greater than one indicates that the data is within the specification. • The larger the Cpk, the more central and within specification the data.

<p>CPm process repeatability</p> <p>Capability index that takes into account variation between the process average and the target. If the process average and the target are the same value, Cpm will be the same as Cpk. If the average drifts from the target, Cpm will be less than Cpk.</p>
--

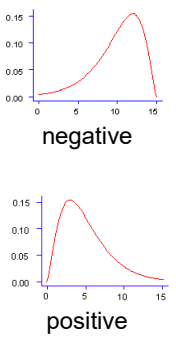
<p>Skewness</p> <div style="display: flex; align-items: flex-start;"> <div style="flex: 1;">  <p style="text-align: center;">negative</p> <p style="text-align: center;">positive</p> </div> <div style="flex: 2; padding-left: 20px;"> <p>An asymmetric frequency distribution is skewed to the left if the lower tail is longer than the upper tail, and skewed to the right if the upper tail is longer than the lower tail. Distributions of positive-valued random variables values are often skewed right.</p> </div> </div> <p style="text-align: center;">Figure 26 Skewness</p>
--

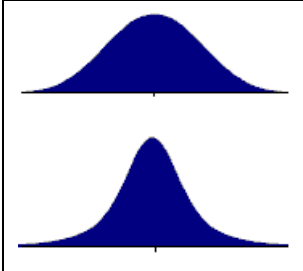
Kurtosis	
	<p>Kurtosis is a parameter that describes the shape of a random variable's probability distribution.</p> <p>The graphs on the left illustrate the notion of kurtosis. The lower curve has higher kurtosis than the upper curve. It is more peaked at the center, and it has fatter tails</p>
<p>Figure 27 Kurtosis</p>	

5.2 Configuration of the view styles

Numeric view configuration
<p>List of parameters that can be adjusted to customize the numeric view display:</p> <ul style="list-style-type: none"> • Display temperature: no, channel temperature • Display mini graph: yes/no • Display time base: yes/no • Upper bound: Adjust graph upper limit • Lower bound: Adjust graph lower limit • Time base: Adjust graph time span • Grid button: Set up the graph to display the x or y axes, the grid, or the thresholds • Auto Scale update: Automatically set the graph upper and lower bounds to best fit the actual values displayed. • Clean button: Clear the slope displayed. The slope restarts from the left side.
Statistic view configuration
<p>Scope:</p> <ul style="list-style-type: none"> • Number of values: Statistic calculation range (from 10 to 1,000 values). Number of value taken in consideration in the log file since last value stored. The recorded values with alarms are not considered for calculation, but are part of the log file. <p>Histogram:</p> <ul style="list-style-type: none"> • Upper limit: Select High or High High alarm value, or a custom value. • Lower limit: Select Low or Low Low alarm value, or a custom value. <p>Capability:</p> <ul style="list-style-type: none"> • Upper limit: Select High or High High alarm value, or a custom value. • Lower limit: Select Low or Low Low alarm value, or a custom value.

Section 6 Measurement Menu

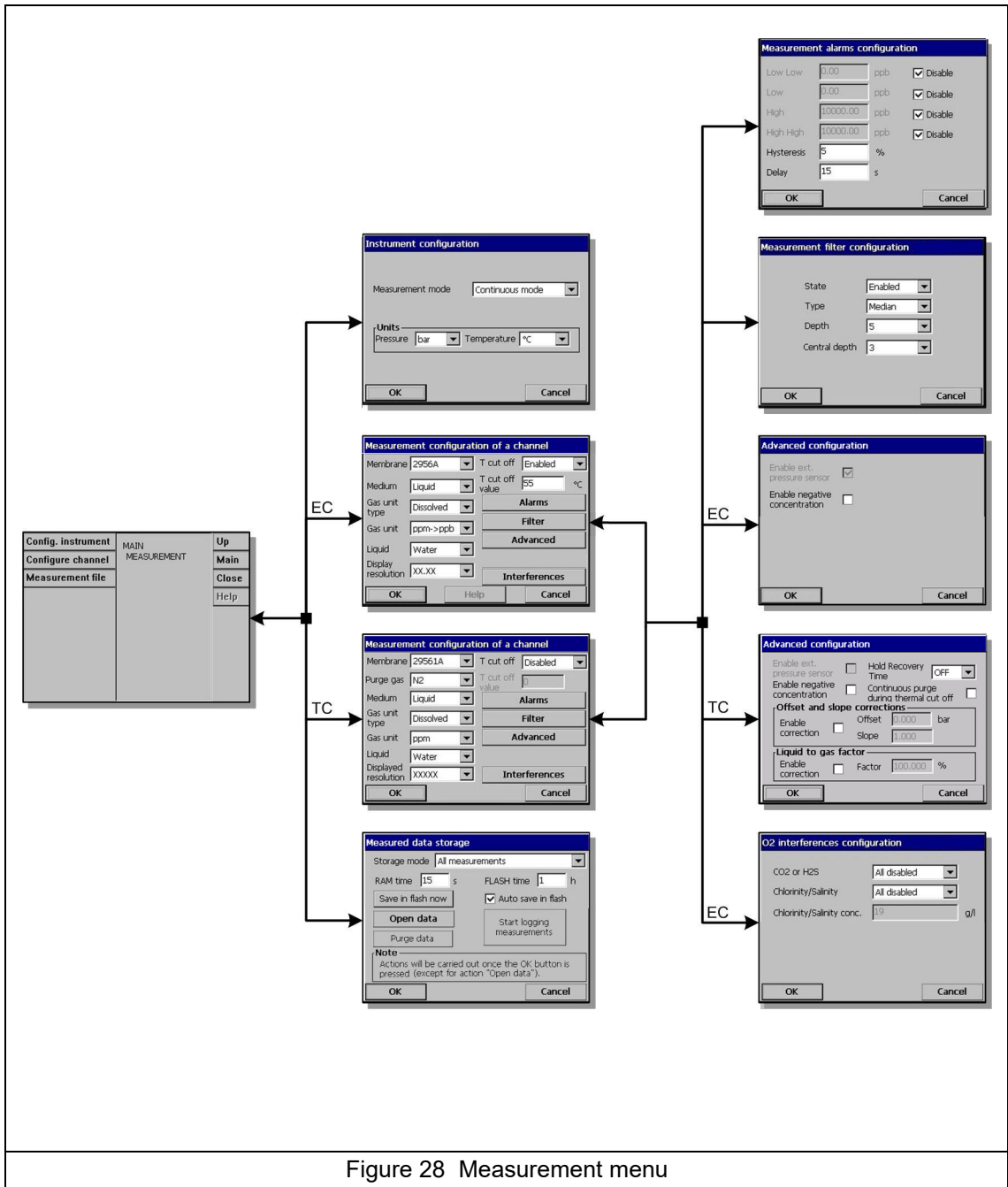

Figure 28 Measurement menu

6.1 Instrument configuration

Continuous mode description
Continuous mode is typically used for process measurement.
Continuous mode cycle
<ul style="list-style-type: none">• Every 2 sec. measurements are refreshed on the display• The relays and the analog outputs are updated• Measurements are continuously stored in memory (volatile and non volatile memory) according to individual settings
Measurement mode is locked on Continuous for on line process. Select the units for barometric pressure and temperature.

6.2 Measurement configuration

EC sensor
<ul style="list-style-type: none">• Sensor's membrane number selection• Medium: Liquid or gas phase.• Gas unit type: Partial, Fraction, Dissolved.• Gas unit: The list of available units depends on unit type selected above.
<i>Note: This is the gas concentration measured by the EC sensor. When a composite unit is selected (e.g. ppm-ppb) the unit will change depending on the range of the value to display.</i>
<ul style="list-style-type: none">• Liquid: When medium is liquid, select water or a liquid with a different solubility (if available).• Display resolution: Maximum resolution depends on gas, membrane and unit. A maximum of 5 digits can be displayed. Decimals can be limited to 0, 1, 2 or 3 decimals for easier reading. That does not affect the actual resolution of data measured and stored, but only the data displayed.• Thermal cutoff: To protect the sensor, the thermal cutoff function allows for setting a sample high temperature limit. If exceeded (during a Cleaning In Place cycle for example) the electrical signal to the sensor is cut off, the measurement session is suspended and the system displays a "HOT" alarm message. The system resumes when temperature drops to 90% of the specified cutoff temperature.<ul style="list-style-type: none">• Thermal cut off options: Disabled / enabled.• Thermal cut off temperature: To be set according to conditions.
TC sensor
The measurement configuration for a TC sensor is the same as for an EC sensor with the addition of one extra selection criteria:
<ul style="list-style-type: none">• Purge gas: From the drop-down list, select the purge gas being used for the TC sensor.

Measurement alarms configuration

Set the thresholds for the low/high concentration levels, according to the application. Each alarm type can be individually enabled or disabled without losing its settings.

These events can activate the relays and can be displayed.

- **Low-low:** 2nd stage for too low concentration
- **Low:** 1st stage for too low concentration
- **High:** 1st stage for too high concentration
- **High-high:** 2nd stage for too high concentration
- **Hysteresis:** A percentage of the above concentration values. The hysteresis is used to prevent relay “flickering” when the measurement is just at the alarm levels. Set this to a minimum, but enough to eliminate flickering.

As an example, if the High Alarm is set to 40 units and the Hysteresis is set to 10%, then the High Alarm is activated once the measurement reaches 40 units, but only deactivated once the measurement drops below 36 units. With the Low Alarm the opposite is true, in that if the Low Alarm is set to 20 units and the Hysteresis set to 10%, then the Low Alarm is activated when the measurement drops below 20 units, and deactivated when the measurement rises above 22 units.

- **Delay:** The delay in seconds, before alarms go on whenever concentration values go above “High alarms” or below “Low alarms”. Set this to a minimum value, but enough to avoid alarms for non-representative peaks beyond the set level.

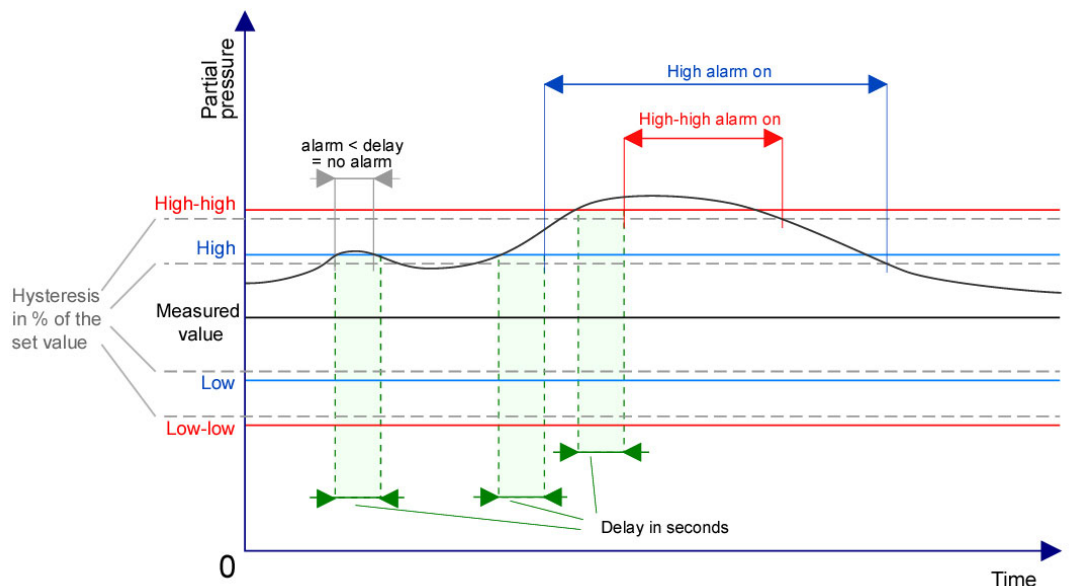

Figure 29 Alarms system diagram

Measurement filter configuration

The filters are aimed at “flattening” the measurement curve in situations where the process shows atypical peak values that could otherwise hamper the interpretation of measurement readings. The filter is applied on the last set of measurements each time a measurement is taken.

- **Mean:** Mathematical average of the last set (depth) of measurement values.
- **Median filter:** Allows for eliminating atypical peak measurement values, and average the remaining ones. The calculation sorts the last measurements set (depth) by values, then delete the highest and lowest values, and averages the remaining values (central depth).

Example for depth 7, central depth 5:

Sorted values, both ends eliminated, the average of the center five is then **3.88**.

0.7 - 1.1 - 4.0 - 4.3 - 4.4 - 5.6 - 7.0

Example for depth 5, central depth 3:

Sorted values, both ends eliminated, the average of the center three is then **4.23**.

1.1 - 4.0 - 4.3 - 4.4 - 5.6

Example for depth 8, central depth 4:

Sorted values, both ends eliminated, the average of the center four is then **4.43**.

0.7 - 1.1 - 4.0 - 4.3 - 4.4 - 5.0 - 5.6 - 7.0

Advanced configuration - EC sensor

- **Enable negative concentration:** Check as appropriate. Refer to [O3 sensor calibration on page 52](#).

Advanced configuration - TC sensor

- **Enable negative concentration:** Check as appropriate.
- **Hold recovery time:** This parameter defines the interval during which the outputs remain frozen after the measurement is no longer on HOLD. Set the value to between OFF and 10 minutes, according to the timing of your setup.
- **Continuous purge during thermal cut off:** If thermal cutoff has been enabled (refer to [Measurement configuration on page 44](#)), then check this box to ensure that a continuous purge of the TC sensor takes place while the measurement session is suspended due to the thermal cutoff temperature value being exceeded.

Note: To manually set the TC sensor into a continuous purge mode, press the **Continuous Purge** button that is available from the **Services - Diagnostic - Channel x - Amplifiers** menu. Refer to [Amplifiers \(TC sensor only\) on page 88](#) for detailed information.

- **Offset and slope corrections:** Enable correction as appropriate.
- If enabled, the correction values for offset and slope must be entered. These values cannot be negative.
- **Liquid to gas factor:** Enable correction as appropriate. If checked, the percentage correction factor must be entered. This value cannot be negative.

Note: If you believe you need to enable these corrections, it is advisable to contact a Hach Lange Service Representative first.

Oxygen interference configuration

These options are available to take into account the influence of some components or gases in the sample during measurement. All available interference corrections are disabled by default.

- Select CO₂, H₂S or all disabled (see notes below).
- Select Chlorinity, Salt or disabled. For chlorinity or salt, it is required to enter the actual concentration in sample.

Note 1: In some applications, like in the beverage industry, there can be high concentrations of CO₂ in the sample. Hach Lange recommends to select "CO₂ interference" whenever a CO₂ concentration of over 1% in gas phase, or 15 ppm in dissolved phase, is present.

Note 2: The detection of O₂ in the petroleum industry is sometime hampered by significant concentrations of H₂S in the sample. Hach Lange recommends to select "H₂S interference" whenever the H₂S concentration exceeds 0.15% in gas phase, or 5 ppm in dissolved phase. To operate the O₂ sensor in these conditions requires using a different sensor and electrolyte. When using this mode your system will experience sensitivity loss of about 50 times higher than the minimum sensitivity for the membrane.

6.3 Measured data storage

Measured data storage

There is one measurement file which contains the data generated by the measurement cycle. The measurement files are updated in volatile memory, and regularly copied in non-volatile memory (file back-up). At start up, the measurement files in volatile memory are updated with the files from the non-volatile memory.

Note: *When the measurement file is full, it is managed as a First in-First out buffer.*

This dialog box allows adjustment of the parameters for recording and storing measurements.

Storage modes:

- No storage
- **Store once:** When the volatile memory is full (1,000 positions), the recording of measurement stops
- **Rolling buffer:** When the volatile memory is full, the latest measurement set replaces the oldest one continuously (first-in, first-out)

Note: *Data stored in volatile memory are lost when instrument is off, non-volatile memory is permanent. In case of an accidental power off event, the instrument resumes measurement storage after the last measurement stored in flash.*

- **RAM time (volatile memory):** Delay in seconds between two recordings of measured data.
- **FLASH time (non-volatile memory):** Delay in seconds between two data file transfers from volatile memory into non-volatile memory. The last data file erases the previous one. This field is only available if the Auto save in flash box is checked.
- **Save in flash now:** Press this button to store measurement data in flash (non-volatile memory) immediately. After pressing this button, press OK to initiate the process. A warning screen appears informing you that the operation can take up to 30 seconds. Press Yes to continue with the process, or No to abort.
- **Auto save in flash:** Check this box to save measurements in flash (non-volatile memory) automatically. Measurements are saved at regular time intervals as defined in the FLASH time box.
- **Start logging measurement:** Store once mode. Starts and stops the measurement recording session. Measurement recording is stopped when the buffer is full.
- **Purge data:** Clear all data for all channels in the volatile and non-volatile memories.
- **Open data:** Opens a table showing the measured values which are stored in the volatile memory (RAM). Use the scroll bar at the right to move to another data range (the id range will be shown in the title bar). The page number being viewed and the total number of pages are shown at the bottom. Use the keys at the bottom to move directly to the first page, previous page, next page or last page.

Section 7 Calibration Menu

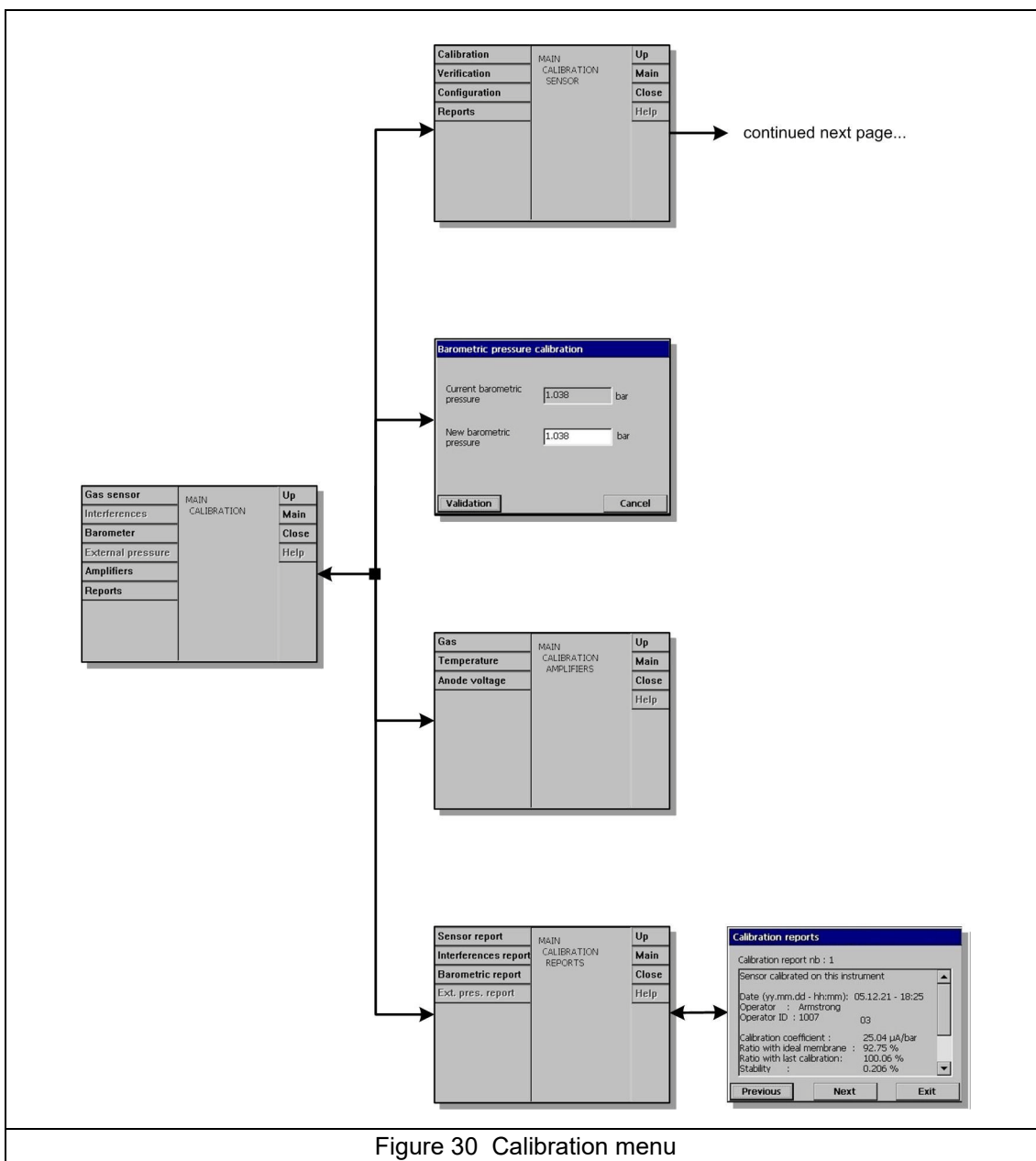

Figure 30 Calibration menu

Note: The amplifiers calibration option is reserved for Hach Lange service technicians only, and is therefore not explained in this manual.

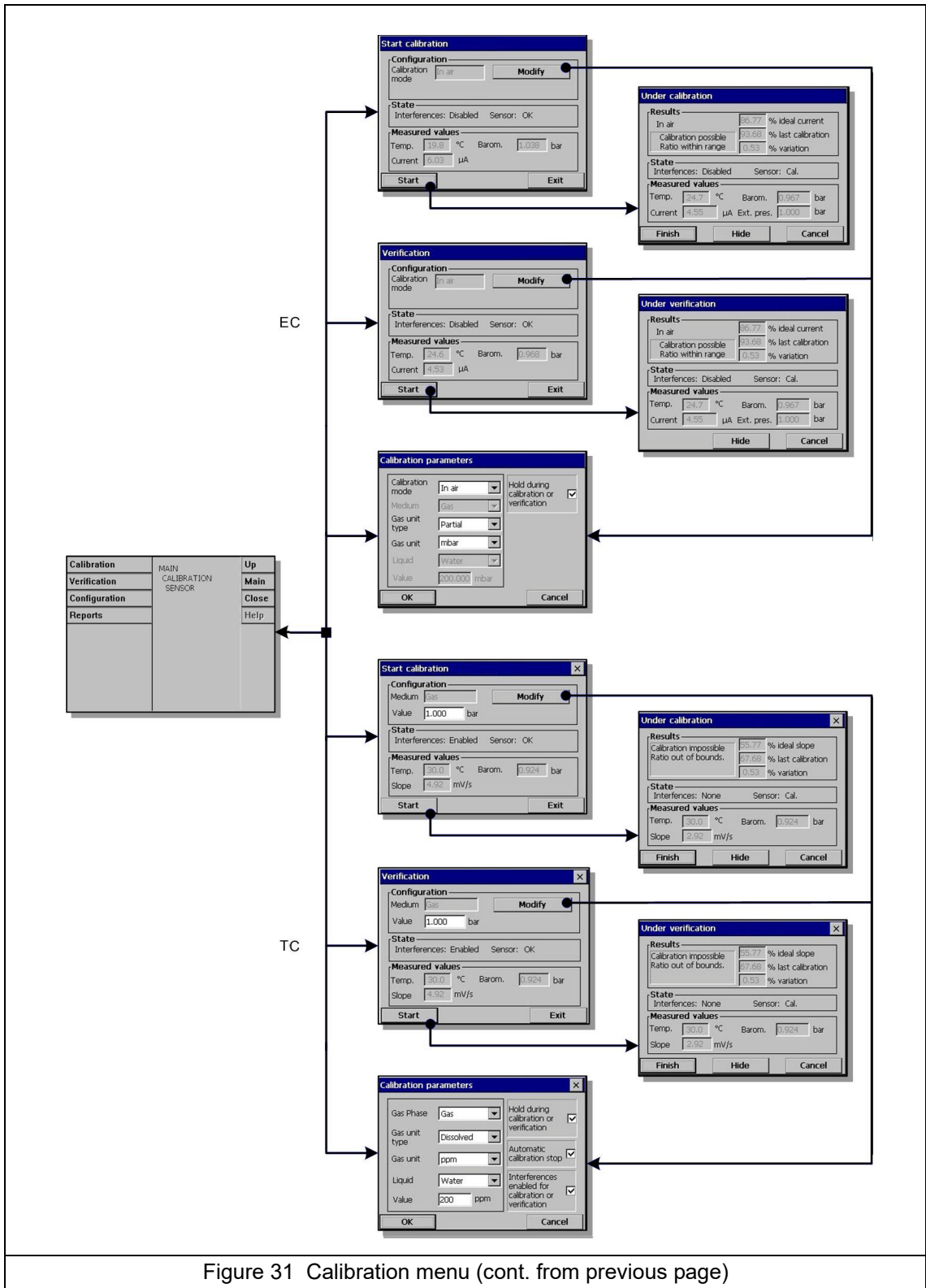

Figure 31 Calibration menu (cont. from previous page)

7.1 Definitions

Definitions
<p>To calibrate the gas to measure (main gas), the user usually puts the sensor in the main gas without any interfering gas.</p> <p>Calibrations can only be performed once the instrument has been installed, configured and the channel has been set up. You must also ensure that you have the correct access rights to access the calibration menu.</p> <p>Select Sensor calibration from the calibration menu. There are two types of gas sensor calibration available:</p> <ol style="list-style-type: none"> 1. In Air: For Oxygen and Ozone with an EC sensor. 2. Direct value: Any gas with either an EC or TC sensor. This calibration exposes the sensor to a gas with a known partial pressure, or a liquid sample with a known gas concentration. <p>Note: All the calibration information for a smart EC Sensor is stored in the sensor's memory. When a smart sensor is connected to the instrument for the first time, a calibration report is automatically generated giving the details of the last calibration. Refer to Calibration reports on page 54.</p> <p>If the sensor being calibrated is an EC sensor, follow the instructions in EC gas sensor calibration. For TC sensors, refer to TC gas sensor calibration on page 53.</p>

7.2 EC gas sensor calibration

Calibration of the measured gas	
Start	<p>Before initiating a calibration process, the calibration parameters must be set by pressing on the Modify button. The last calibration parameters are memorized, so this step can be ignored if the correct parameters are already set.</p> <p>Note: When calibration is started, a calibration event is set, and the analog output and relay are put on hold (if selected below) to avoid unwanted alarms or potential process problems. This resumes when calibration is finished.</p>
Modify calibration parameters	<ul style="list-style-type: none"> • Calibration mode: 2 types available, depending on the gas being measured: <ul style="list-style-type: none"> • Direct value: Any gas • In Air (default): For O₂ or O₃ • Medium: Select liquid or gas (direct calibration only) • Concentration unit type: Partial, fraction or dissolved (dissolved is for calibration in a liquid only) • Concentration unit: The list of available units depends on unit type selected above. • Liquid: Select as appropriate, available when liquid has been selected in medium (above). • Enter the gas concentration according to the value in the calibration media, when direct value is used • Hold during calibration: On by default, this stops any output from the instrument during the calibration process to avoid sending invalid information to any connected device. <p>Press OK to start calibration</p>

Calibration results	<p>A calibration screen will be displayed showing current measurement data which is continually refreshed.</p> <p>The value “% ideal current” is a percentage of the current against the ideal current for the membrane type selected. If this percentage is not within the accepted range, an error message is displayed and the calibration process fails (refer to Calibration errors (EC and TC sensors) on page 54). A warning message can be displayed when this value is close to the boundaries, but when calibration can be accepted.</p> <p>The message is first displayed in the result box. The dialog box with the error message or the warning is displayed when the finish button is pressed.</p> <p>The value “% last calibration” shows the ratio between the current measurement and the previous sensor calibration.</p> <p>The value “% variation” indicates the variation during the last 3 measurements, which is the stability of the measurements. A variation as low as possible is needed for a precise calibration.</p> <p>The display shows the actual calibration parameters, and the actual readings (temperature, barometer, current).</p> <p>Note: <i>In case of calibration failure, consider replacing the membrane. See the sensor maintenance manual for details.</i></p>
Verification	<p>Similar to the calibration procedure, but for verification of the actual calibration values. The result of the measurements made during the verification is not stored and the actual calibration data is not modified.</p>

7.2.1 O₂ sensor calibration

O₂ sensor calibration	
<p>The O₂ sensor needs to be calibrated after each sensor service. Wait at least 30 minutes after mounting a new membrane before recalibrating. The sensor is in contact with either:</p> <ul style="list-style-type: none"> • Air at atmospheric pressure (In Air) • O₂ at known concentration (Direct value). The gas can be dissolved or not. 	
In air calibration	<p>This calibration procedure places the O₂ sensor in water-saturated air, to provide a known oxygen reference against which to calibrate.</p> <p>Dry the sensor thoroughly, before placing the sensor storage cap under tap water. Shake off any excess water, but leave a few drops inside the cap. Verify that the screw-on protection cap is in place on the sensor head. If you use a Dacron mesh inside the protection cap, make sure it is dry before attempting to calibrate. Then, loosely place the storage cap back on the sensor, holding it in place with a few turns of its collar.</p> <p>Set the calibration parameters accordingly (refer to Modify calibration parameters on page 51), and press calibrate.</p>
Direct calibration	<p>This procedure calibrates the oxygen sensor against a liquid sample containing a known level of dissolved O₂ flowing through the sample line.</p> <p>The instrument displays the sensitivity of the sensor as a percentage of the sensitivity determined when calibration was last performed.</p> <p>Set the calibration parameters accordingly and press calibrate. Refer to Modify calibration parameters on page 51.</p>

7.2.2 O₃ sensor calibration

O₃ sensor calibration	
<p>The sensor is either in contact with:</p> <ul style="list-style-type: none"> • Air at atmospheric pressure (In Air) • O₃ at known concentration (Direct Value). The gas can be dissolved or not. <p>The procedure is the same as for the O₂ sensor. In the case of the In air calibration, the sensor measures O₂ during calibration. The O₃ coefficient is deduced taking into account how the sensor behaves in O₂. As a different voltage is used at the anode to measure O₂ and O₃, the O₃ measurement takes a long time to stabilize.</p> <p>To facilitate the follow up after an O₃ in air calibration, negative values can be displayed.</p>	

7.3 TC gas sensor calibration

Calibration of the measured gas	
Start	<p>Before initiating a calibration process, the calibration parameters must be set by pressing on the Modify button. The last calibration parameters are memorized, so this step can be ignored if the correct parameters are already set.</p> <p>Similarly, if only the calibration value has changed, then this can be updated directly instead of pressing the Modify button.</p> <p>Note: <i>When calibration is started, a calibration event is set, and the analog output and relay are put on hold (if selected below) to avoid unwanted alarms or potential process problems. This resumes when calibration is finished.</i></p>
Modify calibration parameters	<ul style="list-style-type: none"> • Gas Phase: Select liquid or gas (direct calibration only) • Gas unit type: Partial, fraction or dissolved (dissolved is for calibration in a liquid only) • Gas unit: The list of available units depends on unit type selected above. • Liquid: Select as appropriate. • Enter the gas concentration according to the value in the calibration media. • Hold during calibration: On by default, this stops any output from the instrument during the calibration process to avoid sending invalid information to any connected device. • Automatic calibration stop: If selected, when the stability criteria is reached, the calibration process stops automatically. • Interferences enabled: Option not available. <p>Press OK to start calibration</p>
Calibration results	<p>A calibration screen will be displayed showing current measurement data which is continually refreshed.</p> <p>The value “% ideal current” is a percentage of the current against the ideal current for the membrane type selected. If this percentage is not within the accepted range, an error message is displayed and the calibration process fails. Refer to Calibration errors (EC and TC sensors) on page 54. A warning message can be displayed when this value is close to the boundaries, but when calibration can be accepted.</p> <p>The message is first displayed in the result box. The dialog box with the error message or the warning is displayed when the finish button is pressed.</p> <p>The value “% last calibration” shows the ratio between the current measurement and the previous sensor calibration.</p> <p>The value “% variation” indicates the variation during the last 3 measurements, which is the stability of the measurements. A variation as low as possible is needed for a precise calibration.</p> <p>The display shows the actual calibration parameters, and the actual readings (temperature, barometer, current).</p> <p>Note: <i>In case of calibration failure, consider replacing the membrane. See the sensor maintenance manual for details.</i></p>
Verification	<p>Similar to the calibration procedure, but for verification of the actual calibration values. The result of the measurements made during the verification is not stored and the actual calibration data is not modified.</p>

7.4 Calibration errors (EC and TC sensors)

Calibration errors (EC and TC sensors)
<p>The calibration is not possible in the following circumstances:</p> <ul style="list-style-type: none">• When the "ratio ideal current" is greater than 170% or smaller than 30%• When the sensor cannot measure (thermal cut off, sensor out, etc.)• When the "ratio ideal current" is greater than 150% or smaller than 50%, a warning is displayed but the calibration is valid.

7.5 Barometric pressure calibration

Barometric pressure calibration
<p>Upper box shows the barometric pressure measured by the instrument.</p> <p>Using a precision certified barometer, measure barometric pressure in the location where the measuring instrument is used. Compare the values, if values are the same press Cancel, otherwise enter the new barometric value in the lower box and Validate the new setting.</p> <p>On completion a calibration report is created.</p> <p><i>Note: The barometric sensor has been factory calibrated.</i></p>

7.6 Calibration reports

Calibration reports
<p>Once a calibration is completed (for a gas or pressure sensor), the calibration report is updated with the new details. The calibration report contains data for the last 10 calibrations.</p> <p>For full details on the data displayed for all the different type of calibration reports. Refer to Data available on page 67 for examples.</p> <p>Each calibration record will contain parameters useful for traceability. For instance, it will contain:</p> <ul style="list-style-type: none">• the user name and ID• the date and time• the calibration coefficient• all the measurements which influence the calibration (temperature, barometric pressure, current, etc.) <p>Calibration reports are generated after a sensor calibration. In addition, once a smart sensor is connected to the instrument for the first time, a calibration report is automatically generated giving details of the last calibration of that sensor.</p>

Section 8 Inputs/Outputs Menu

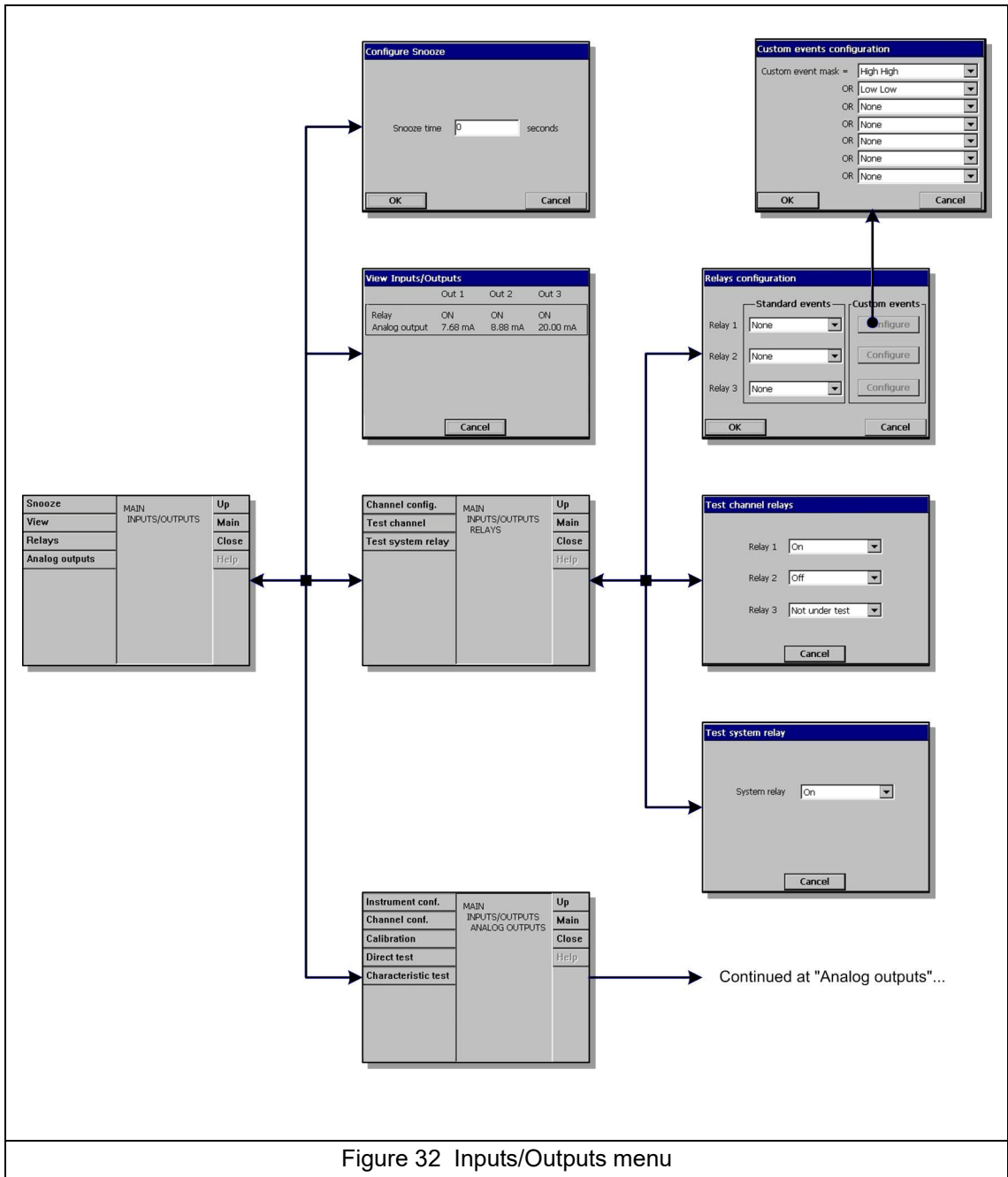

Figure 32 Inputs/Outputs menu

8.1 Configure snooze

Configure snooze
In the event of an alarm, the “snooze” button stops the instrument buzzer and returns all the relays in the instrument to their normal state during a “snooze time”. Enter the snooze time in seconds and press OK .

8.2 View inputs/outputs

View inputs/outputs
This view option displays the state of the 3 alarm relays (on or off), and the analog output current (or voltage, depending on the instrument version) value for each.

8.3 Relays

Relays	
<p>There are three measurement alarm relays and one system alarm relay for the instrument. These relays are configurable as either standard or custom events through the instrument menu.</p> <ul style="list-style-type: none"> • An alarm relay can be activated or deactivated • When the alarm is OFF, it is activated, • When the alarm is ON, it is deactivated <p>All the relays are activated as soon as the instrument is ON (but alarms are OFF). When the instrument is OFF, the relays are deactivated, thus in this state, all alarms are ON. The logic "Relay deactivated = Alarm ON" has been chosen for this safety reason.</p> <p>When the main board does not communicate with the measurement board for more than 30 seconds, the measurement board switches all the alarm relays and the analog output to the alarm state.</p>	
Relays configuration	<p>The three relays can be triggered by several standard events, or a combination of events (custom). The relays output can be used to turn on a beacon, horn or PLC . Refer to Connections to electronic boards on page 28.</p> <p>Note: Relays can be set to Normally Open [NO] or Normally Closed [NC] by changing the jumper positions on the measurement board . Refer to Measurement alarm relays on page 31.</p> <ul style="list-style-type: none"> • Select a standard event in the rolling list • If “Custom event” has been selected, it has to be configured by touching the configure button • Press on the text box to open the selection menu (rolling menu). Select the events that must trigger the relay, and press OK. <p>Proceed in the same manner for other events that should trigger the relay.</p>
Test channel relays	<p>The three measurement alarm relays can be manually activated for testing purposes:</p> <ul style="list-style-type: none"> • Select Relay On, Off or Not under test. <p>See note regarding the relays below. “Not under test” means the relay is in operating mode, and it will be triggered normally.</p> <p>Note: A relay set to NO will close when activated (On), but a relay set to NC will open. Refer to Measurement alarm relays on page 31.</p>
Test system relay	<p>Similarly, the system alarm relay can be manually activated for testing purpose.</p> <ul style="list-style-type: none"> • Select Relay On, Off or Not under test.
<p>Note: In both the Test Channel Relays and Test System Relay options above, once the tests have been completed press Cancel to exit the screen. At the same time, this will reset all relays (including the system relay) back to a status of “Not under test”.</p>	

8.4 Analog outputs

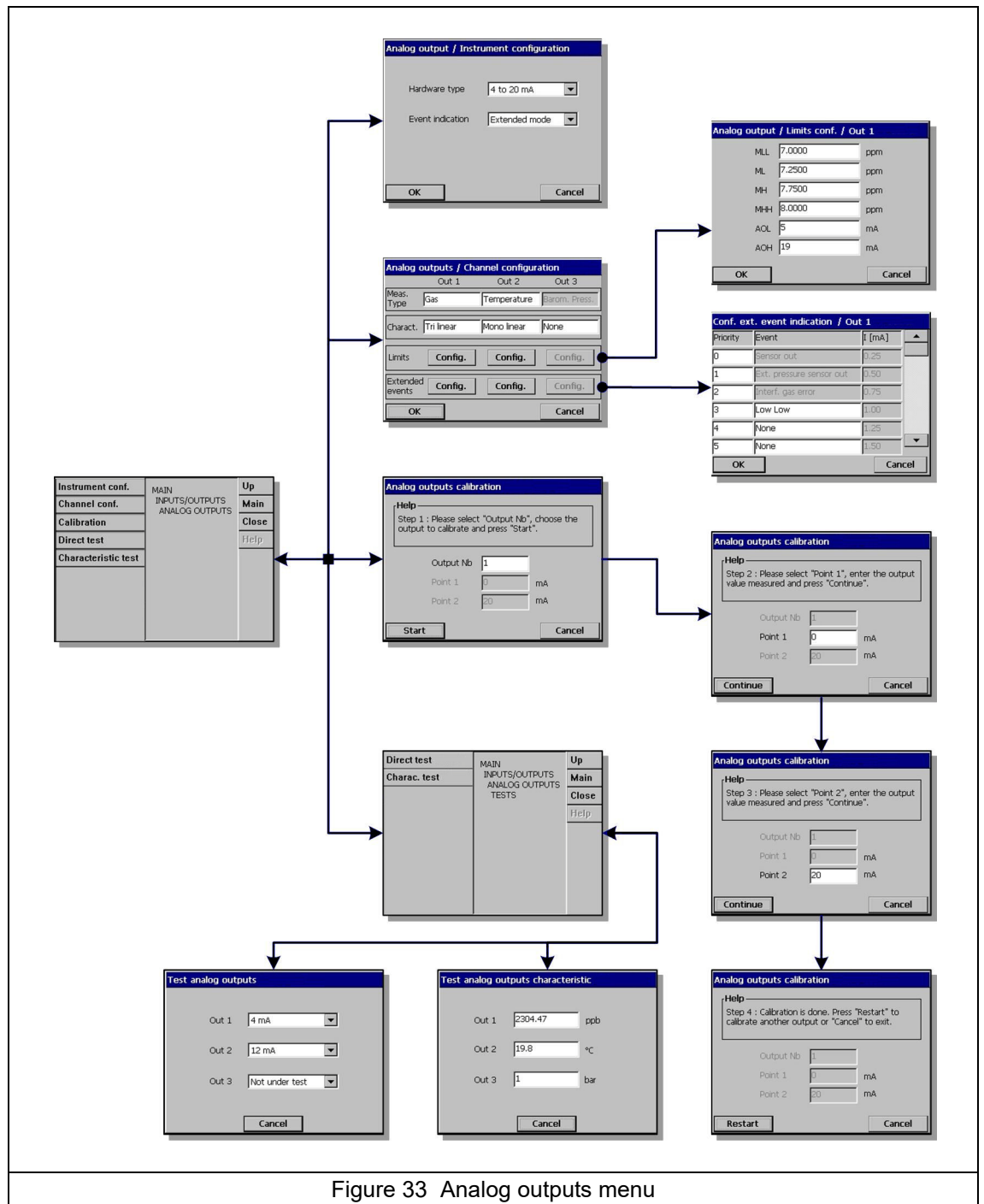

Figure 33 Analog outputs menu

Analog outputs	
<p>There are three analog outputs available. These outputs are configurable in terms of function, content, and behavior through the instrument menus. Analog outputs are used to output a voltage or a current which is a function (e.g. a linear characteristic) of a measurement: $AOut = f(M)$. The analog outputs can be typically connected to a PLC. Knowing the function (f), the PLC can compute the value of the measurement.</p> <p>Two types of instrument hardware are available:</p> <ul style="list-style-type: none"> • measurement board with current output ($I = 0-20$ mA or $4-20$ mA). • measurement board with voltage output ($U = 0-5$ V). 	
Instrument configuration	<ul style="list-style-type: none"> • Select analog output range of current: 4-20 mA or 0-20 mA • The 4-20 mA range (recommended) allows for an extended event indication mode that can be selected and configured (default = standard mode) <p>Note: Features of the instrument with a voltage analog output are similar to the 0-20 mA features.</p> <p>For some events (sensor out, purge failure, etc.) the actual measurement is not significant, but the PLC needs to know how the analog output behaves in these cases. Two "Event indication modes" are available:</p> <ul style="list-style-type: none"> • Standard mode (default) • Extended mode
Standard event indication	Refer to Table 1 Standard event indication below.
Extended event indication	<p>The "Extended event indication" mode is only available when the 4-20 mA output is selected. In this mode, the range between 0 mA and 4 mA is used to indicate selected events. The events are defined using the channel configuration option. Refer to Channel configuration on page 59.</p> <p>Note: The extended mode is not available for the voltage output versions of the instrument.</p>

Table 1 Standard event indication

Analog output	Event output range			Event
	0-20 mA	4-20 mA	0/5 V	
Gas concentration	20 mA	20 mA	5 V	<ul style="list-style-type: none"> • Channel out • Sensor out • Thermal cut-off • Interfering gas error
Temperature	20 mA	20 mA	5 V	<ul style="list-style-type: none"> • Channel out • Sensor out

Analog outputs (continued)	
Channel configuration	<p>Set the type of measurement that will be transmitted through each output channel, and the output characteristics.</p> <ul style="list-style-type: none"> • Meas. type: Select between the type of measurements available in the rolling list. • Characteristics: Select either Linear, Tri-linear or None. Refer to Analog output characteristics on page 61. • Limits: Press the configure button to adjust the analog output set points for each output. Enter values in the appropriate text boxes. In Linear mode, only the ML and MH values can be adjusted. Tri linear mode allows all limits to be adjusted, and the None mode denies access to this screen. <p>The authorized user may define a maximum of 12 customized events for each analog output and change the order of priority of all events.</p> <p>Note: <i>This only applies to Tri linear and Linear outputs. It is not available if the output characteristic is set to None.</i></p> <p>Configure the events that should be signaled at the corresponding current shown in the right column.</p> <ul style="list-style-type: none"> • Only one event signal at a time can be sent via the current output. As there is a possibility to have several events at the same time, an order of priority must be set. This order has been set by default, but it can be modified to suit particular needs and conditions. Touch the priority number in the left column and edit it. • The shaded events in the list have preset outputs and only the priority can be changed. The other events can be customized by the user. Touch a white text box to call up the rolling list. Select an event from this list and press OK. Then adjust the priority as required. <p>Note: <i>When an event occurs, measurement information is superseded by the event information on the output.</i></p>

The following table lists the default configuration. The first three events on the list are pre-set and only the priority can be changed:

Priority	Event	I [mA]
0	Sensor out	0.25
1	External pressure sensor out	0.50
2	Interfering gas error	0.75
3	Custom Event 1	1.00
4	Custom Event 2	1.25
5	Custom Event 3	1.50
6	Custom Event 4	1.75
7	Custom Event 5	2.00
8	Custom Event 6	2.25
9	Custom Event 7	2.50
10	Custom Event 8	2.75
11	Custom Event 9	3.00
12	Custom Event 10	3.25
13	Custom Event 11	3.50
14	Custom Event 12	3.75

Analog outputs (continued)	
Calibration of the analog output	<p>The calibration of the analog output is aimed at aligning the internally calculated current to the real current output. This was performed at factory, but could become necessary again because of electronic tolerances. A precision amperometer (or voltmeter for the voltage versions) connected at the corresponding analog output connection point is required. Refer to Measurement board on page 30.</p> <ul style="list-style-type: none"> • Select the analog output channel to calibrate and press the Start button. • Measure with the amperometer the current value for point 1. It should be below 4 mA • Edit point 1 and enter the same value as read on the amperometer, then press the Continue button. • Measure with the amperometer the current value for point 2. It should be above 20 mA. • Edit point 2 and enter the same value as read on the amperometer, before pressing the Continue button. <p>Calibration of the selected analog output channel is completed.</p>
Direct test	<p>Test to check the calibration of the analog outputs. A precision amperometer connected at the analog output connection point is required.</p> <ul style="list-style-type: none"> • Select a value (4, 12, 20 mA available) for each channel and compare this value (± 0.02 mA) with what the amperometer shows. <p>A calibration is required if the value on the amperometer differs from the current selected ± 0.02 mA).</p> <p>Note: <i>It is possible to test one analog output without interfering with the others. During the test, the other analog outputs will continue to indicate the measurement.</i></p>
Characteristics test	<p>This is a test for the correct operation of the peripherals connected to each analog output, by verifying that the PLC computes the correct value. The analog output will send the current corresponding to the value entered in the text boxes.</p> <ul style="list-style-type: none"> • Type in a test value for each analog output, and check for the related action on the peripheral.

8.5 Analog output characteristics

Analog output characteristics	
“Linear” analog output	The "Linear" output is the default setting for the analog output. It is illustrated below (4-20 mA output is shown, 0-20 mA or 0-5 V settings are similar).
<p>The graph shows 'Analog signal intensity' on the y-axis (ranging from 4 [mA] to 20 [mA]) and 'Measure' on the x-axis. Three ranges are defined: Range 0 (Measure < MLow), Range 1 (MLow < Measure < MHigh), and Range 2 (Measure > MHigh). In Range 0, the signal is constant at 4 mA ('Analogic signal low'). In Range 1, the signal increases linearly from 4 mA to 20 mA ('Analogic signal range'). In Range 2, the signal is constant at 20 mA ('Analogic signal high'). A double-headed arrow above the x-axis indicates the 'Expected range of measure' between MLow and MHigh.</p>	
	<p>The goal of this setting is to use all the points available on the slope from 4 mA to 20 mA to show the range of measurements that are usual in the measured process. Setting the output this way allows for the highest signal resolution for the actual conditions.</p> <p>The downside is that any measures below the set range will have the same analog signal locked at 4 mA. Similarly, any measure over the set range will have the same analog signal locked at 20 mA. Settings must be made in balancing these aspects.</p> <p>Settings</p> <p>For the output, set ML and MH in the current measuring unit (e.g. °C for a temperature output). When a compound unit is selected the smallest unit will be used (e.g. ppb for a "ppm-ppb" compound unit).</p> <p>These points should be set keeping in balance the following conditions (see illustration above):</p> <ul style="list-style-type: none"> • The smaller is Range 1, the better is the analog signal resolution within the expected range of measure. • In Range 0 the analog output only shows that measurement is below the ML value. Similarly in Range 2 the analog output only shows that measurement is over the MH value. <p>The formula to compute the measurement knowing the current I (or voltage U) and the resolution R is given in the following table:</p>

Linear	Range	Measurement M	Resolution R
4-20 mA	$20 > I > 4$	$M = ML + (MH - ML) \cdot (I - 4) / 16$	$R = (MH - ML) / 808$
0-20 mA	$20 > I > 0$	$M = ML + (MH - ML) \cdot I / 20$	$R = (MH - ML) / 1010$
0 - 5 V	$5 > U > 0$	$M = ML + (MH - ML) \cdot U / 5$	$R = (MH - ML) / 1010$

Analog output characteristics (continued)	
<p>“Tri-linear” analog output</p>	<p>The “Tri-linear” output brings benefits over the “Linear output” discussed before. It is illustrated below (4-20 mA output is shown, 0-20 mA or 0-5 V settings are similar).</p>
	<p>Compared to the “Linear” mode, the expected range of measure is Range 2. A Range 1 and 3 are available to show the measures falling out of this Range 2, but normally at a lower resolution. Expected measurements for the measured process are supposed to be in Range 2 most of the time, and in Range 1 or 3 occasionally (problems, calibration, line stop, etc.). The benefits are:</p> <ul style="list-style-type: none"> • The PLC can compute the measurement over a large range (1, 2 and 3). • The PLC can compute a higher resolution signal for the expected measuring range (Range 2: $MH > M > ML$). • Carefully selecting the set points allows for an individual resolution for each range, so a different resolution can be applied to Range 1, 2 and 3, allowing to tailor the analog output to the actual conditions. <p>As before, the downside is that any measure below or over the Range 1, 2 and 3 will have the same signal locked at 4 mA and 20 mA respectively, but Range 1, 2 and 3 should cover a larger range than in the “Linear” mode. Settings must be made in balancing these aspects.</p> <p>Settings</p> <p>For each output, set MLL, ML, MH, and MHH in the current measuring unit (e.g. °C for a temperature output). When a compound unit is selected, the smallest unit will be used (e.g. ppb for a “ppm-ppb” compound unit). Also set AOL (Analog Output Low) and AOH (High) in mA (or Volts).</p> <p>These points should be set keeping in balance the following conditions (see illustration above):</p> <ul style="list-style-type: none"> • The smaller is Range 2, the better is the analog signal resolution within the expected range of measure. • Size of Range 1 and 3 should be set to deliver an adequate level of resolution for the measures falling out of the expected range of measure. • In Range 0 the analog outputs only shows that measurement is below the MLL value. Similarly in Range 4 the analog output only shows that measurement is over the MHH value. <p>The formula to compute the measurement knowing the current or the voltage and the resolution R is given in the following table:</p>

Tri-linear	Range	Measurement M	Resolution R
4-20 mA	1: $AOL \geq I > 4$	$M = MLL + (ML - MLL) \cdot (I - 4) / (AOL - 4)$	$R = (ML - MLL) \cdot 20 / ((AOL - 4) \cdot 1010)$
	2: $AOH \geq I > AOL$	$M = ML + (MH - ML) \cdot (I - AOL) / (AOH - AOL)$	$R = (MH - ML) \cdot 20 / ((AOH - AOL) \cdot 1010)$
	3: $20 > I > AOH$	$M = MH + (MHH - MH) \cdot (I - AOH) / (20 - AOH)$	$R = (MHH - MH) \cdot 20 / ((20 - AOH) \cdot 1010)$
0-20 mA	1: $AOL \geq I > 0$	$M = MLL + (ML - MLL) \cdot I / AOL$	$R = (ML - MLL) \cdot 20 / (AOL \cdot 1010)$
	2: $AOH \geq I > AOL$	$M = ML + (MH - ML) \cdot (I - AOL) / (AOH - AOL)$	$R = (MH - ML) \cdot 20 / ((AOH - AOL) \cdot 1010)$
	3: $20 > I > AOH$	$M = MH + (MHH - MH) \cdot (I - AOH) / (20 - AOH)$	$R = (MHH - MH) \cdot 20 / ((20 - AOH) \cdot 1010)$
0-5 V	1: $AOL \geq U > 0$	$M = MLL + (ML - MLL) \cdot U / AOL$	$R = (ML - MLL) \cdot 5 / (AOL \cdot 1010)$
	2: $AOH \geq U > AOL$	$M = ML + (MH - ML) \cdot (U - AOL) / (AOH - AOL)$	$R = (MH - ML) \cdot 5 / ((AOH - AOL) \cdot 1010)$
	3: $5 > U > AOH$	$M = MH + (MHH - MH) \cdot (U - AOH) / (5 - AOH)$	$R = (MHH - MH) \cdot 5 / ((5 - AOH) \cdot 1010)$

Analog output characteristics (continued)	
None	<p>This is the default value.</p> <p>Setting the analog output to “None” means that the output value will always be zero and importantly ensures that no current is emitted on that output, so reducing power consumption as well as reducing heat within the instrument.</p>

Section 9 Communication Menu

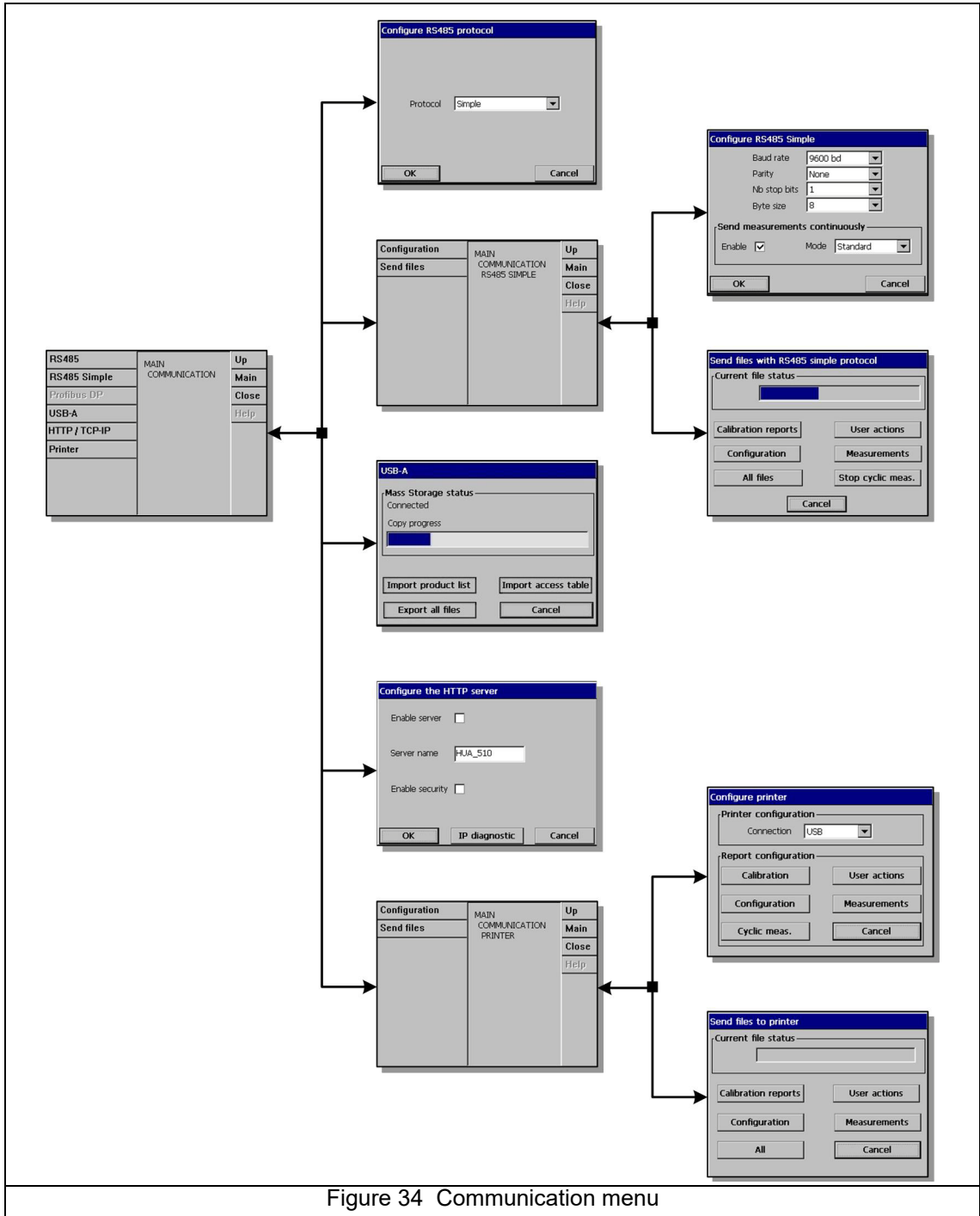
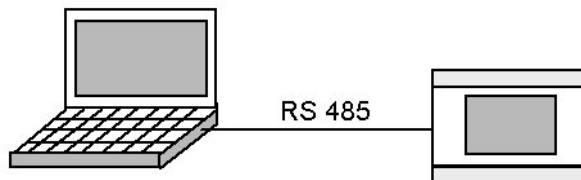

Figure 34 Communication menu

The external RS-485 port of the main board is directly connected to a RS-485 bus (single twisted pair). Optionally it can be connected to a fieldbus module (gateway).

The RS 485 menu allows to select between RS485 simple or Profibus DP communication protocol, depending on application.

- Click on the text box to select either the RS-485 simple or the PROFIBUS-DP communication protocol.



9.1 RS-485 simple mode configuration

This protocol allows the instrument to output data to an external device (PLC, SCADA, PC, etc.). The communication is unidirectional. The data are output on the RS-485 link as simple ASCII text. If for instance you use a PC, the data can be easily visualized and saved in a file using the "Hyperterminal" software.

To use this communications mode, on the instrument:

- Select the **RS-485** option from the **Communication** menu
- Choose the protocol **Simple** (default configuration) and press on **OK**
- Then select the **RS-485 Simple** option from the **Communication** menu:
 - "Baud rate", "Parity", "No of stop bits", "Byte size" Standard parameters of the RS-485 link.
 - "Enable" The measurements can be sent continuously (approximately every 2 sec.). This field allows enabling or disabling this feature.
 - "Mode" This is the format of the measurements sent continuously. Refer to [Cyclic measurements on page 67](#). In "Expert" mode, more data are sent. These additional data can be useful for diagnostic purpose.

Note: In case of problem verify first that jumper J3 is not installed on the mother board (default configuration).

Send data

This dialog box is used to send text files to an external device. The possible files are the following:

- Calibration reports
- User actions log file
- Instrument configuration

Measurements stored in the instrument memory.

The button "Stop Cyclic meas." allows to stop and to restart the cyclic transmission of measurements. It is advised to stop the cyclic transmission in order not to mix cyclic measurements and data of the file being transmitted. This button has the same effect as the "Enable" checkbox of the "Communication/RS-485 Simple/Configuration" window.

After stopping the cyclic measurements, select the "Calibration Reports", "User Actions", "Configuration", "Measurements" button to send the corresponding file, or the "All files" button to send all these files in one shot.

Once the button is pressed, the file is sent immediately. The field "Current file status" shows "Sending" alongside the file transmission progress bar. On completion this changes to "Sent".

9.1.1 Data available

All individual data are separated by at least one tabulation character (ASCII code=0x09).

For the cyclic measurements, the data format is detailed. For the files, only one example for each file is given to explain the data format.

Cyclic measurements

1. If the option "Mode = standard" is chosen, the following message is sent:

CHn\t	Gas\t	Gas Unit\t	Temperature\t	Temperature Unit\t	Barometric Pressure\t	Barometric Pressure Unit\t	Event\t\r\n
-------	-------	------------	---------------	--------------------	-----------------------	----------------------------	-------------

with:

- \tthe ASCII tab character: code=0x09
- \rthe ASCII Carriage Return character: code=0x0D
- \nthe ASCII Line Feed character: code=0x0A
- CHnthe 2 ASCII characters "CH" + the channel no.
- Gasthe gas concentration.
- Gas Unitthe gas unit.
- Temperaturethe temperature.
- Temperature Unit.....the temperature unit.
- Barometric Pressure.....the barometric pressure.
- Barometric Pressure Unitthe barometric pressure unit.
- Eventthe event bit mask in hexadecimal format.

The values are not described here. Refer to [List of events and alarms on page 92](#).

- Example of one measurement:

CH1 697.176 mbar 20.1 °C 0.982 bar C00

2. If the option "Mode = expert" is chosen, the following message is sent:

CHn\t	Gas\t	Gas Unit\t	Temperature\t	Temperature Unit\t	BarometricPressure\t	Barometric Pressure Unit\t		
Event\t	Current\t	µA\t	Partial pressure\t	bar\t	External Pressure\t	External Pressure Unit\t	Time\t	Index\r\n

with:

- CurrentThe current measured in [microA].
- Partial pressureThe partial pressure in [bar].
- External PressureThe external pressure.
- External Pressure Unit.....The external pressure unit.
- TimeThe time of the measurement. Format "hh:mm:ss."
- Index.....This is the index of the last measurement.

This number starts at 0 at power up of the program.

- Example of one measurement:

CH1 697.173 mbar 20.1 °C 0.982 bar C00 80.056229 µA 0.697
bar 1.000 bar 12:59:42 5923

Gas sensor calibration report example

Calibration report nb 1
 Type Sensor calibrated on this instrument
 Date (yy.mm.dd - hh:mm) 05.02.17 - 18:40
 Operatorjp
 Operator ID3
 Calibration coefficient 122.40 µA/bar
 Ratio with ideal membrane ... 92.72 %
 Ratio with last calibration 97.35 %
 Stability 0.000 %
 Calibration mode Direct value
 Calibration value 0.750000
 Gas unit.bar
 Gas phase.....Liquid
 Liquid.....Water
 Interferences Disable
 Temperature 20.1 °C
 Barometric pressure 1.020 bar
 External pressure 0.976 bar
 Sensor current..... 79.857 µA

Smart gas sensor connection calibration report example

Calibration report nb 1
 Type Sensor calibrated on another instrument
 Date (yy.mm.dd - hh:mm) 05.01.17 - 15:30
 Operator Armstrong
 Calibration coefficient 62.75 µA/bar
 Connection date 05.03.15 - 12:26
 Serial number 1
 Membrane.....2956A

Barometric sensor calibration report example

Calibration report nb 1
 Date (yy.mm.dd - hh:mm) 05.02.16 - 20:38
 Operatorjp
 Operator ID3
 Former barometric pressure ... 0.970 bar
 New Barometric pressure 0.971 bar

User action log file example

The "User action log file" below contains 3 user actions.

<i>Nr</i>	<i>mm/dd</i>	<i>hh:mm:ss</i>	<i>User ID</i>	<i>User Name</i>	<i>Action ID</i>	<i>Description</i>
1	1/21	15:13:44	1007	Armstrong	140	Measurement config.
0	1/21	15:13:27	1007	Armstrong	132	Identification
2	1/21	15: 9:15	1007	Armstrong	132	Identification

Measurement file example

6 measurements are described below:

<i>Nr</i>	<i>mm/dd</i>	<i>hh:mm:ss</i>	<i>Gas</i> <i>[ppb]</i>	<i>Temp</i> <i>[°C]</i>	<i>Mask</i>	<i>Fluor. phi</i> <i>[°]</i>	<i>Barom</i> <i>[bar]</i>	<i>Ext P.</i> <i>[bar]</i>	<i>Index</i>
0	2/17	21:15:37	75.051	20.1	400	26.039	1.005	0.000	2271
1	2/17	21:15:27	75.043	20.1	400	26.045	1.005	0.000	2266
2	2/17	21:15:17	75.047	20.1	400	26.052	1.005	0.000	2261
3	2/17	21:14:57	75.044	20.1	400	26.041	1.005	0.000	2256
4	2/17	21:14:47	75.047	20.1	400	26.038	1.005	0.000	2251
5	2/17	21:14:37	75.050	20.1	400	26.054	1.005	0.000	2246

Configuration report example

The "Configuration" below is given for a one channel instrument.

```

INSTRUMENT CONFIGURATION
Measurement mode . . . . . Continuous mode
Pressure unit . . . . . [bar]
Temperature unit . . . . . [°C]
Storage mode . . . . . Rolling buffer
Storage RAM time . . . . . 10 [s]
Storage FLASH time . . . . . 3600 [s]

Channel 1
Membrane . . . . . 2956A
Medium . . . . . Liquid
Gas unit . . . . . mbar
Liquid . . . . . Water
Resolution displayed . . . . . 3
Thermal cut off . . . . . Enabled60.0 [°C]
Alarms
Low Low . . . . . Disabled0.000000 [mbar]
Low . . . . . Disabled0.100000 [mbar]
High . . . . . Enabled5.000000 [mbar]
High High . . . . . Disabled1.100000 [mbar]
Hysteresis . . . . . 1 [%]
Delay . . . . . 0 [s]
Filter State . . . . . Disabled
Type . . . . . Median
Depth . . . . . 5
Central depth . . . . . 3
Interferences
CO2 or H2S . . . . . All disabled
Chlorinity/Salinity . . . . . All disabled19.000000 [g/l]
H2 . . . . . Disabled0.100000 [bar]

```

9.1.2 Example of use

In this example we use:

- One PC with a RS232 port.
- One "RS-485<->RS232 converter"

Procedure:

1. Connect both RS-485 wires of the instrument to the "RS-485<->RS232 converter".
2. Connect the "RS-485<->RS232 converter" to the PC RS232 port using a standard cable (RS232 DB9 straight cable).

On the PC:

1. Run "Hyperterminal" on the PC.
2. Configure the PC COM port used (e.g. COM2). Menu "File/Properties/Configure".
3. Configure the parameters "Baud rate", "Parity", "Nb of stop bits", "Byte size" (Menu "File/Properties/Configure"). Use the same parameters for the instrument and the PC.
4. Configure the "Font = Courier 10" (Menu "View/Font").
5. Connect "Hyperterminal" (Menu "Call/Call").
6. Save the data received in the file of your choice (Menu "Transfer/Capture Text/Start").

On the instrument:

1. Use the menu "Communication/RS-485 Simple/Send files" and the button "All files".

When the transfer is finished, close the file with "Hyperterminal" (Menu "Transfer/Capture Text/Stop"). Now, all the reports are saved in a text file on your PC.

9.2 PROFIBUS-DP communication (optional)

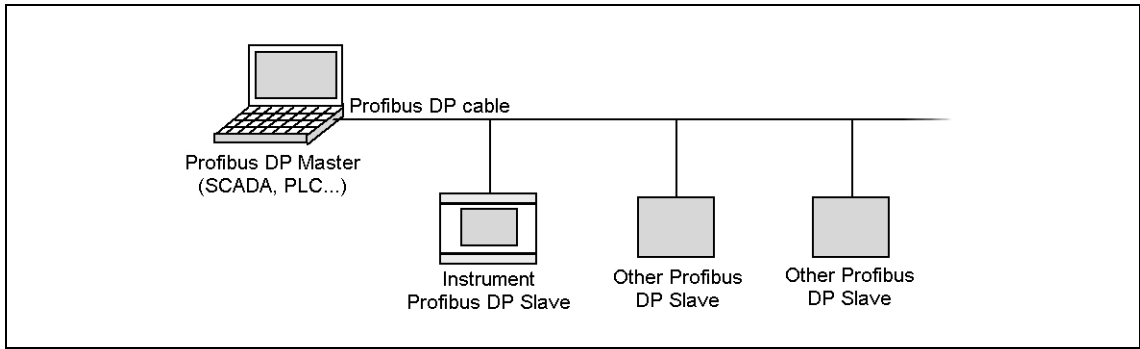

9.2.1 Installation

On the ORBISPHERE CD, there is an "Orbi3218.gsd" and an "Orbi3218.bmp" file available in the "Profibus DP" folder to help configure the PROFIBUS-DP. The GSD file contains the following elements:

- The module **Gateway Version \geq 2.0 - 1 channel** for receiving data from the instrument.
Note: Gateway version \geq 2.0 and user software version \geq 2.15 are mandatory
- The module **Gateway Version $<$ 2.0** for receiving data from an instrument equipped with a profibus gateway version $<$ 2.0 or user software version $<$ 2.15

WARNING



Potential Electrocutation Hazard. Always disconnect power to the instrument when making electrical connections.

CAUTION

Personal Injury Hazard. Only qualified personnel should conduct the tasks described in this section of the manual.

NOTICE



Potential Instrument Damage. Proper ESD (electrostatic discharge) protocols must be followed to prevent damage to the product. All fittings must be properly seated and tightened to prevent any water and dust ingress.

1. Install the PROFIBUS-DP module and the jumper J3 on the main board (location highlighted in the illustration below).

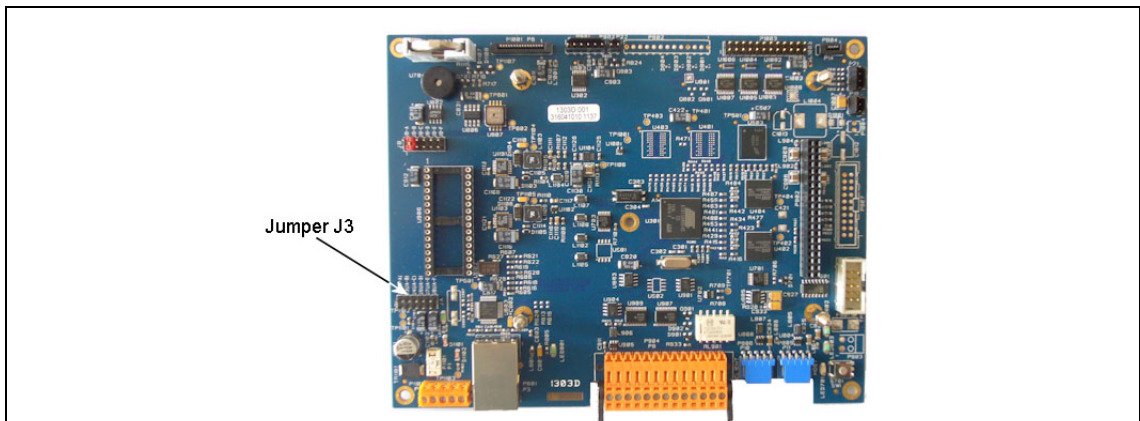

2. Select the menu "Configuration/RS-485" and choose "PROFIBUS-DP" as the protocol.
3. Select the menu "Configuration/PROFIBUS-DP", choose the slave address and restart the instrument.

9.2.2 Input/Output data

The main board:

- Writes the latest measurement data to the Profibus Input Buffer.
- Checks if a command written by the Profibus Master must be executed (Profibus Output Buffer). If a command is to be executed, the instrument executes it and writes the result (status, data, etc.) in the Profibus Input Buffer.

All numbers are coded in “Big Endian” format, and float values are coded according to IEEE Standards. The field types “Byte” and “Double Word” are unsigned.

Measurements

Measurements are formatted in the Profibus Input Buffer as follows:

Name	Type	Size	Offset
Barometric pressure	Input float	32 bits	0
Barometric pressure unit	Input byte	8 bits	4
Channel 1 gas concentration	Input float	32 bits	5
Channel 1 gas unit	Input byte	8 bits	9
Channel 1 temperature	Input float	32 bits	10
Channel 1 temperature unit	Input byte	8 bits	14
Channel 1 external pressure	Input float	32 bits	15
Channel 1 external pressure unit	Input byte	8 bits	19
Channel 1 events	Input double word	32 bits	20
Channel 1 measurement index	Input double word	32 bits	24

The gas, temperature and barometric pressure unit values are coded as defined in the following tables:

Gas unit	Value
bar	0
mbar	1
Pa	2
kPa	3
hPa	4
psia	5
atm.	6
mbar->bar	9
Pa->KPa	10
%Vbar	12
ppm Vbar	13
%Vext	14
ppm Vext	15
ppm Vbar->%Vbar	16
ppm Vext->%Vext	17
ppm	18
ppb	19
g/l	20
mg/l	21
µg/l	22
%O ₂	23
%Air	24
g/kg	25
V/V	26
%W	27
cc/kg	28
ml/l	29

Temperature unit	Value
K	0
°C	1
°F	2

Barometric pressure unit	Value
bar	0
mbar	1
psia	2
atm.	3
Pa	4
kPa	5
hPa	6

Note: For the field "Event", refer to the column "Bit mask value" in [Table 4 on page 92](#).

Note: If the instrument stops sending measurement data to the module, then after 30 seconds the module sets the event mask to the value **PROFIBUS-DP value not updated** (0x80000000) bit mask.

Commands

The “Command Output Buffer” is formatted as follows:

Name	Type	Size	Offset
Output command toggle (OCT)	Output byte	8 bits	0
Output command ID (OCI)	Output byte	8 bits	1
Output command data byte 1 (OCD1)	Output byte	8 bits	2
Output command data byte 2 (OCD2)	Output byte	8 bits	3
Output command data byte 3 (OCD3)	Output byte	8 bits	4
Output command data byte 4 (OCD4)	Output byte	8 bits	5

The “Command Input Buffer” is located just after the measurement data and is formatted as follows:

Name	Type	Size	Offset
Input command toggle (ICT)	Input byte	8 bits	28
Input command status (ICS)	Input byte	8 bits	29
Input command data byte 1 (ICD1)	Input byte	8 bits	30
Input command data byte 2 (ICD2)	Input byte	8 bits	31
Input command data byte 3 (ICD3)	Input byte	8 bits	32
Input command data byte 4 (ICD4)	Input byte	8 bits	33

The following commands are available:

- Change product
- Activate sensor (valid for EC sensors only)
- Set channel hold status (valid for TC and LDO sensors only)

Change product command - output

Name	Value	Comment
OCT	1-2	
OCI	1	Command ID
OCD1	0	Channel number: 0 = Channel 1
OCD2	0-99	Product number
OCD3	0-1	Erase measurement files: 0 = Never erase the measurement files. 1 = Erase measurement file if necessary (e.g. gas unit changes)
OCD4		Not used

Change product command - input

Name	Value	Comment
ICT	1-2	
ICS	0-3	0 = OK 1 = Unknown command ID 2 = Invalid parameter (e.g. invalid channel no or product number) 3 = Execution failure
ICD1		Not used
ICD2		Not used
ICD3		Not used
ICD4		Not used

Activate sensor command - output

Name	Value	Comment
OCT	1-2	
OCI	2	Command ID
OCD1	0	Channel number: 0 = Channel 1
OCD2	0-1	Sensor activation: 0 = Deactivate the EC sensor 1 = Activate the EC sensor
OCD3		Not used
OCD4		Not used

Activate sensor command - input

Name	Value	Comment
ICT	1-2	
ICS	0-3	0 = OK 1 = Unknown command ID 2 = Invalid parameter (e.g. invalid channel no) 3 = Execution failure
ICD1		Not used
ICD2		Not used
ICD3		Not used
ICD4		Not used

Set channel hold status- output

Name	Value	Comment
OCT	1-2	
OCI	3	Command ID
OCD1	0	Channel number: 0 = Channel 1
OCD2	0-1	Status: 0 = Channel enabled 1 = Channel on hold
OCD3		Not used
OCD4		Not used

Set channel hold status - input

Name	Value	Comment
ICT	1-2	
ICS	0-3	0 = OK 1 = Unknown command ID 2 = Invalid parameter (e.g. invalid channel no) 3 = Execution failure
ICD1		Not used
ICD2		Not used
ICD3		Not used
ICD4		Not used

9.3 USB-A port (host)

This option allows the export or import of data from an external mass storage device. The device must first be connected to the instrument through the USB-A port.

Select one of the two import options (product list or access table) to import data from the storage device. This is useful for transferring these files to additional instruments without the need of having to re-enter the data individually on each instrument.

Note: *The imported data will override any current settings on the instrument.*

Select the export option to export data from the instrument to the storage device. This will export all stored data: measurements, calibrations, product list, access table, etc.

For both import and export options, the progress bar is updated to give an indication of the progress of the selected option.

The USB-A port is also used to update the instrument software. If the software is present on the USB storage device, the update process starts automatically.

9.4 HTTP/TCP-IP

9.4.1 Overview

When activated this option downloads data from the instrument directly to a web page that can be accessed from a PC. To be able to use this option, the instrument must be connected to the network (specifically **Connector P3** - Refer to [Main board connections on page 29](#) for details). The network must have a DHCP server installed.

- Check the Enable server box to enable the web server communication link.
- Enter the Server name for the instrument. This is free format text and should typically be used to identify the instrument.
- Check the Enable security box if you require a password to be entered on the PC to access the web page.

If any of the details on the previous screen have been changed, a warning message will be displayed as illustrated left.

The changes must be confirmed, after which the instrument must be powered down and powered up again for the changes to take effect.

Note: *The IP Diagnostics button at the bottom of the screen is for use by experienced IT personnel only to help resolve any communications problems.*

9.4.2 PC interface

Once the server has been enabled and the interface information set up, access the information by launching an internet browser and typing “**http://**” followed by the server name that has been assigned to the instrument, in the address box as illustrated below:

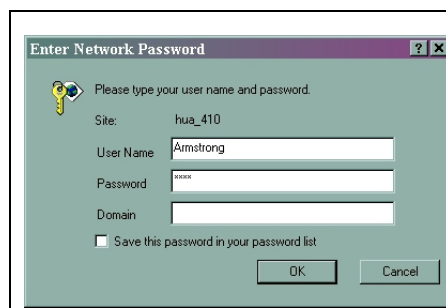

If the enable security option has been checked on the instrument, you will be required to enter a username and password on your PC to gain access to the web page.

The username and password must be a valid username/password combination that has been set up on the instrument. Refer to [User management on page 80](#) for users set up instructions. Domain information is not required.

Once a valid username/password combination has been entered, the initial web page will be displayed giving a list of options:

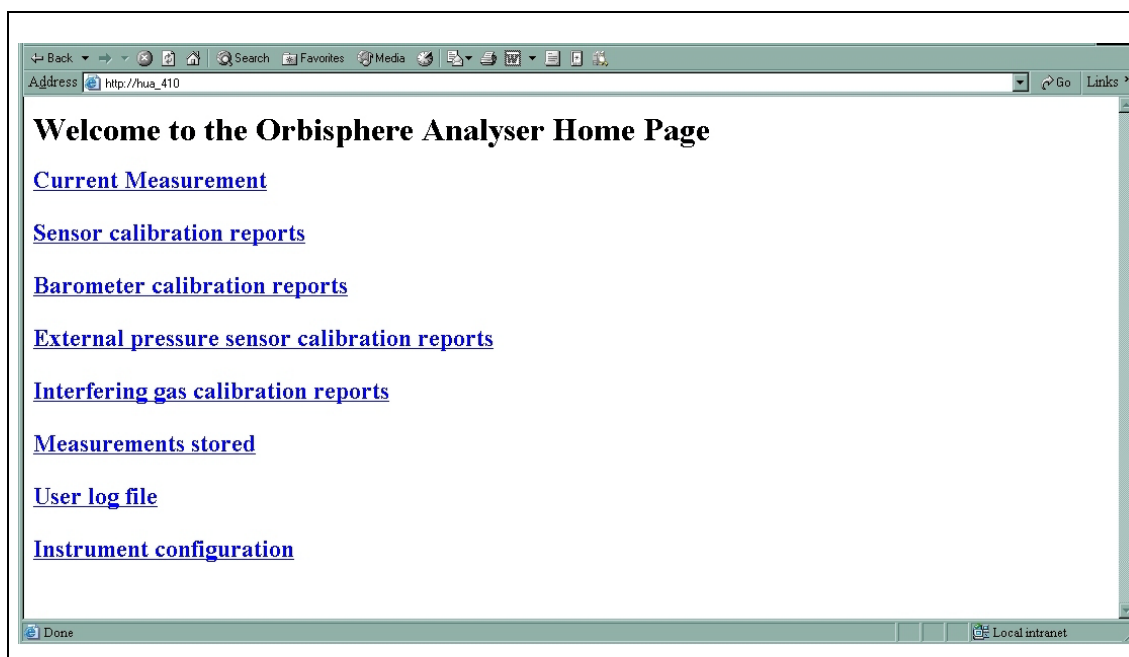

Click on any of these options and the data will be displayed on the PC screen. The following shows an example of the screen when selecting the Current Measurement option:

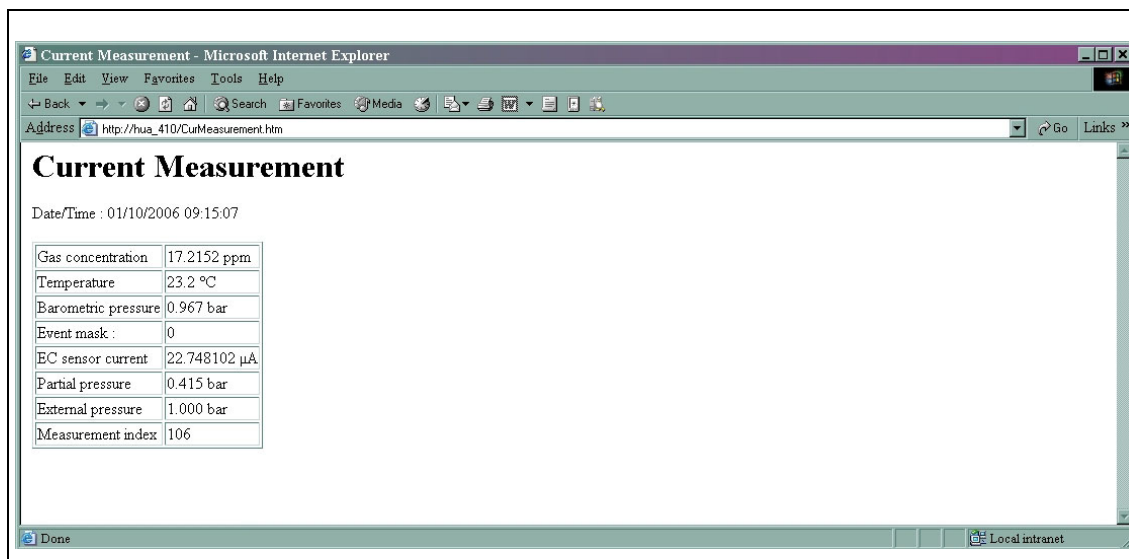

9.5 Printer

This menu provides the facility to print a number of reports directly to a printer. The printer must be connected to the instrument through the instrument USB-A port.

The following information is available for printing:

- Calibration reports
- User action log files
- Instrument configuration details
- Measurements stored in the instrument memory
- Cyclic measurements for continuous printing

Configuration	
Printer configuration	Currently only the USB port is a valid printer connection.
Report configuration	<p>Calibration - Choose the channel(s) for which calibration reports are required. Choose to print the last report or all reports for the selected channel(s).</p> <p>User actions - Define the date and time criteria for which user action logs are required.</p> <p>Configuration - Choose the channel(s) for which instrument configuration details are required.</p> <p>Measurements - Choose the channel(s) for which measurement reports are required. Define the start and end times for the measurement reports.</p> <p>Cyclic measurements - Check the enable continuous mode checkbox and choose the channel(s) for which cyclic measurements are required.</p> <p>Cancel - Exit the configuration option.</p>
Send files	
<p>Choose the report (or All) to print the reports that match the configuration criteria. A status bar at the top of the screen shows printing progress.</p> <p>Push the Cancel button to cancel a print job.</p>	

9.5.1 Install ferrite on the printer cable

Refer to the following steps for the ferrite installation on the USB printer cable included with the LQV161.xx.20000 printer:

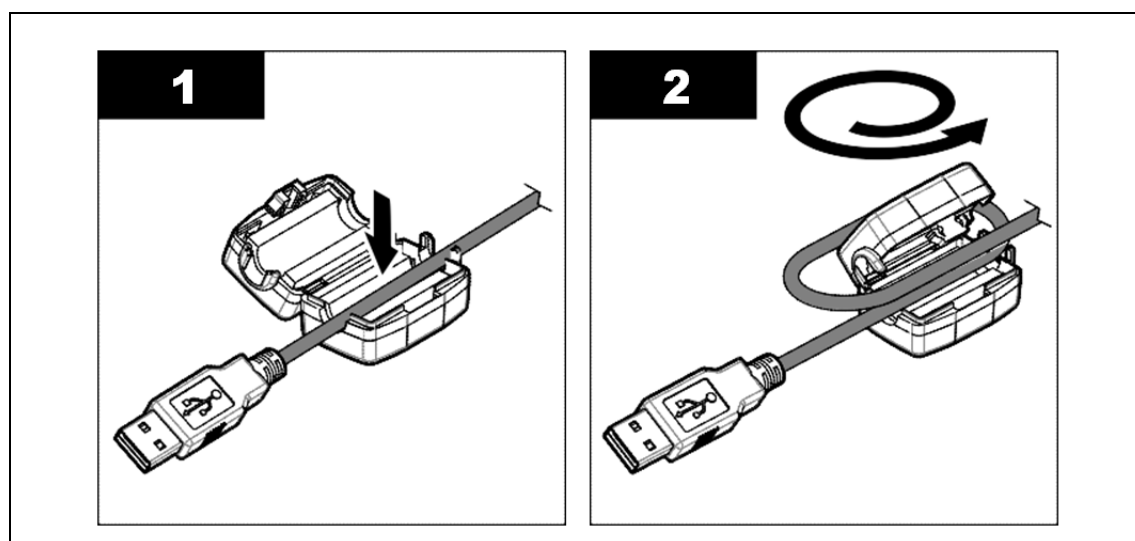

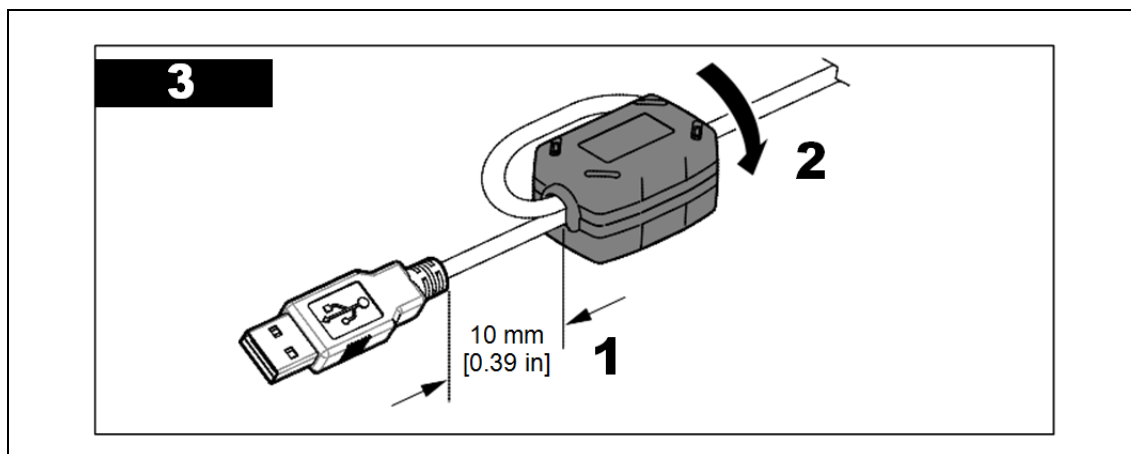

9.5.2 Printer error messages

Error message	Meaning
Printer not available	Indicates that no printer has been detected. Check that the printer is connected to the USB-A port and is powered on.
Paper out	Indicates that the printer is out of paper. In cyclic mode, it is necessary to activate cyclic printing after reloading paper in the printer. In other modes, printing can be restarted directly.
Unknown error	An unidentified error has been detected that prevents printing. If this error occurs, refer to the printer User Manual to identify the cause of the problem.

Note: Cyclic measurement mode is automatically disabled when an error occurs. After the error is corrected, reactivate the cyclic mode in the report configuration option if cyclic measurements are required.

Section 10 Security Menu

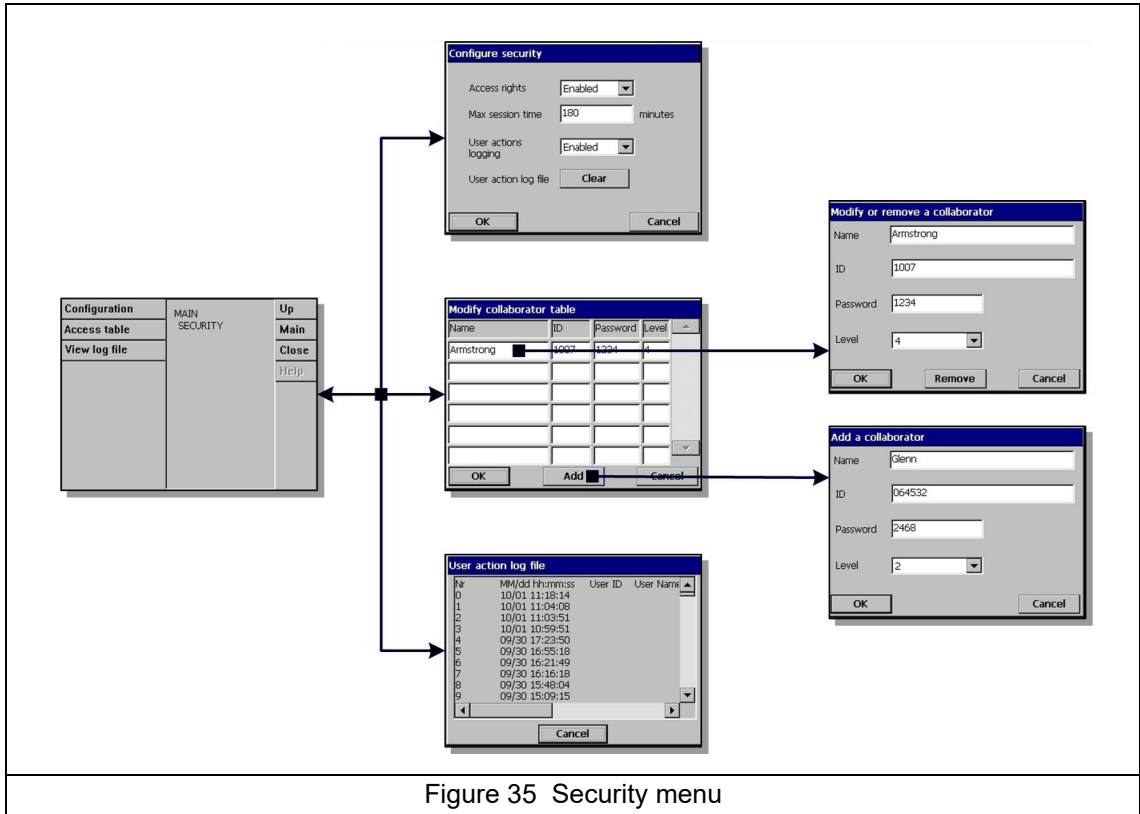

Figure 35 Security menu

Note: When the instrument is started for the very first time, security is disabled by default. It is highly recommended that each user be entered into the system and given appropriate access rights as soon as possible to avoid any unauthorized access. Details of this process are described in this section.

10.1 Access rights management

Access rights management	
Each user has a unique ID and user password. The ID and password are used by the software to:	
<ul style="list-style-type: none"> • Allow or deny a user to perform specific actions. • To trace this action with his "ID" in a log file. 	
Once the ID and password are entered, the user is allowed to perform actions according to the "Access level" that has been attributed to his ID by the Manager. Refer to Security level table on page 15 .	

Level	Typical rights	Comments
0	View parameters, change views	Press the unlock button and OK to access
1	+ Start / Stop measurements	
2	+ Calibration	
3	+ Modify parameters	
4	+ Modify table "User ↔ Access level" + Enable/Disable "Access right" features	There is at least one ID having the level 4

Note: At startup, all the menus are locked. The user has to identify himself to get access beyond the different views. Refer to [Function keys on the header bar on page 34](#).

10.2 Configure security

Configure security
<p>This enables defining the users with their access level when the software starts for the first time. It is possible to configure several parameters related to confidentiality. This requires a user access level 4.</p> <p>Note: <i>Access rights are disabled by default.</i></p> <ul style="list-style-type: none">• Access rights: When enabled, it is required to log in as a registered user. Refer to User management on page 80 to access the menus. When disabled (default), all menu are access free, and the effect of leaving the text box blank in user login window is that there will be no name recorded for the action in the log file.• Enter a maximum session time in minutes for improved confidentiality. The user is logged out automatically when the set delay for inactivity is over.• User action logging: When enabled, every action from a logged on user is recorded in a user log file for traceability.• Clear all user actions log file. Confirm to clear the log file. This functionality is aimed at clearing demo or test logs for example. The log file is a rolling buffer recording the past 100 actions.

10.3 User management

User management
<p>This window shows the list of registered users for the instrument. They are listed by name, ID, password and access level.</p> <p>Note: <i>The "User password" must be at least 4 characters long.</i></p> <p>Pressing on an empty line, or pressing the Add button brings a window to add a new user. Name, ID, password and access level (from 1 to 4) must be entered.</p> <p>Pressing on a registered user line brings a window for editing or deleting the user data in the list.</p> <p>Note: <i>The list can contain up to 99 users</i></p>

10.4 User action log file

User action log file
<p>Each time the user performs an important action, a record is written in the "User action log file". It is a rolling buffer which contains the last 1000 user actions. The "User Interface" will allow viewing this log file (Menu Security / View log file). This log file contains the following data:</p> <ul style="list-style-type: none">• line number• the action name• the user name and ID• the current date and time. <p>Note: <i>Unsuccessful attempts to register are recorded in the log file without a user ID.</i></p>

Section 11 Products Menu

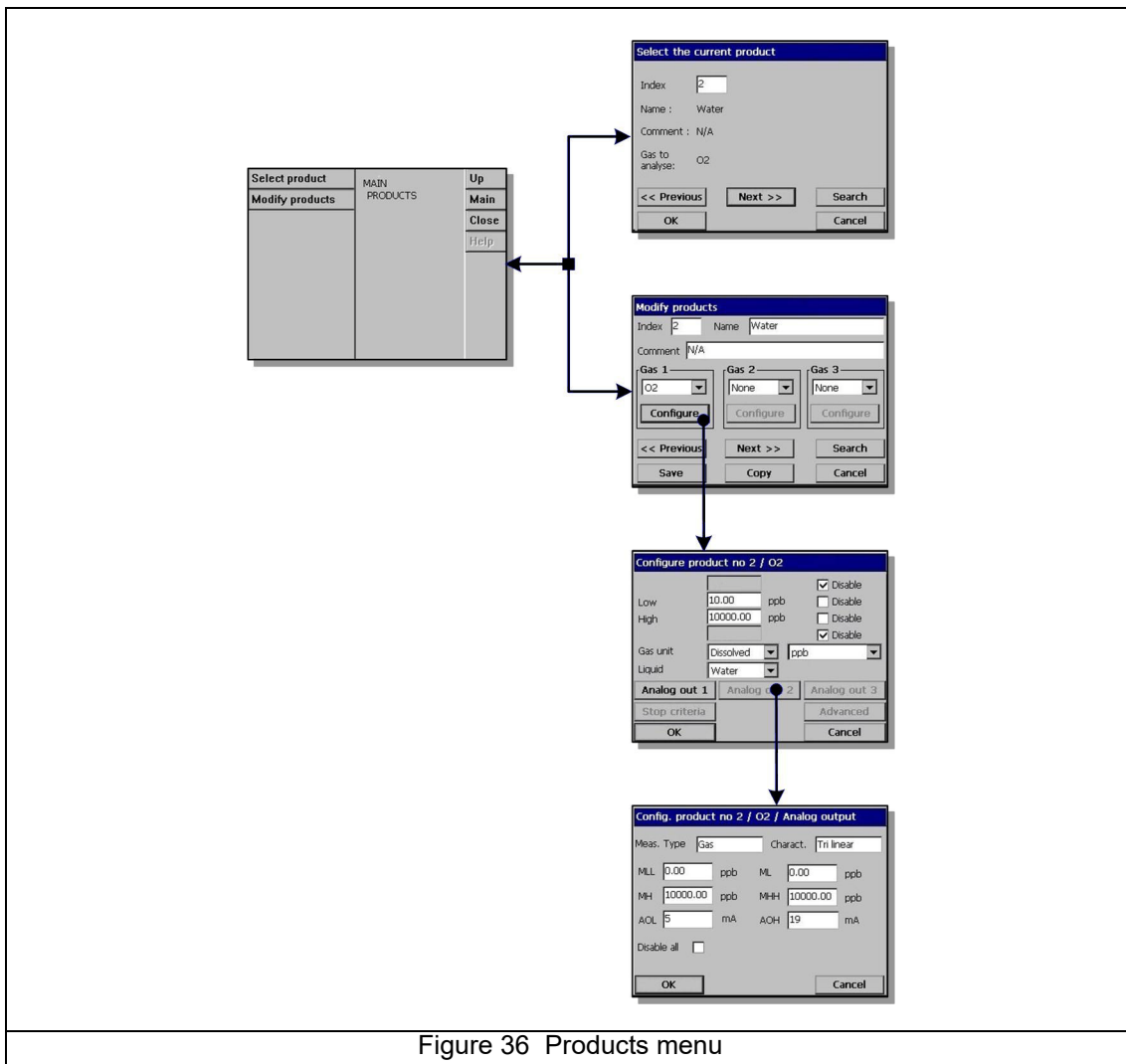

Figure 36 Products menu

Products	
<p>This option allows users to save and/or use previously saved product configurations. A maximum of 100 different product configurations can be stored in the instrument. The basic measurement configuration (gas to analyze, gas unit, alarm limits, analog outputs, etc.) can be set up for a product and will be automatically used by the instrument when that product is selected.</p> <p>Product configurations can be moved from instrument to instrument if required. However, as the sensor only analyzes oxygen, only products configured to analyze oxygen can be selected on this instrument. Products configured to analyze other gases can, however, be set up on this instrument and easily transferred to other 410 or 51x instruments analyzing gases other than oxygen.</p> <p>For ease of use, where product configurations are identical or similar, a Copy facility exists on the modify product screen. This enables copying a stored configuration and storing it in one or more additional locations. Then use the modify product option to identify and/or modify the duplicate configurations.</p>	
Select product	<p><i>Note: If the PROFIBUS-DP communications protocol has been enabled, products can be selected for analysis using that facility. Refer to Input/Output data on page 71 and Change product command - output on page 73 for details.</i></p> <ul style="list-style-type: none"> Select the product (0-99) to be analyzed, or use the Next and Previous buttons to scroll sequentially through the existing product list. Alternatively, use the Search facility to search for a product. Enter a full or partial search criteria. If only one match is found, this product is automatically selected. If a number of products match the search criteria, then a list of matches will be displayed. Select a product directly from the list of matching products. Press OK to select the product or Cancel to exit.
Modify product	<ul style="list-style-type: none"> Select the product (index 0-99) to modify, or use the Next and Previous buttons to scroll sequentially through the existing product list. Alternatively, use the Search facility to search for a product. Enter a full or partial search criteria. If only one match is found, this product is automatically selected. If a number of products match the search criteria, then a list of matches will be displayed. Select a product directly from the list of matching products. Select the gas to analyze (up to three can be selected) from the drop down list. After selecting a product and gas, press Configure to configure the product. Configure the product as required. Refer to Measurement configuration on page 44 for additional information. Press Analog out to configure the analog outputs. Configure the analog output as required. Refer to Channel configuration on page 59 for additional information. Press OK to accept the configuration, or Cancel to exit.

Section 12 Global Configuration Menu

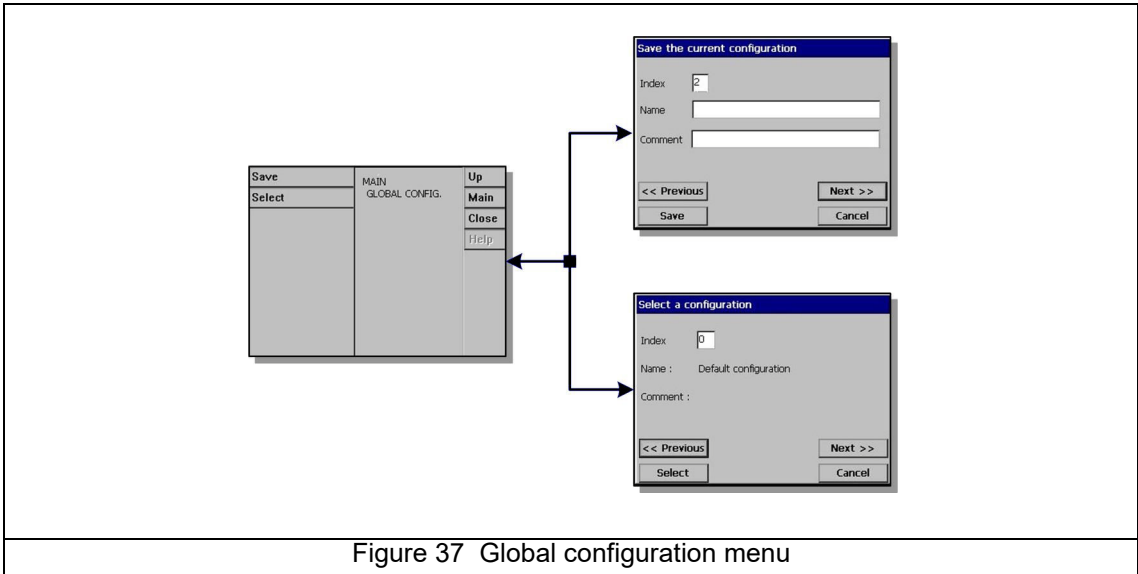

Figure 37 Global configuration menu

Global configuration	
<p>The global configuration option allows users to save, and use previously saved, instrument configurations. A maximum of 10 configurations can be saved, with configuration 0 (zero) the instrument default.</p> <p>Once all the instrument parameters have been set up, use this option to save the configuration. Selecting pre-defined configurations avoids the need to re-enter all the parameters when using the instrument for a different application.</p>	
Save	<ul style="list-style-type: none"> Define the index (1-9) to save the current configuration. Use the Next and Previous buttons to scroll sequentially through existing configurations, to overwrite an existing configuration or save as a new one. Enter a name to define the current configuration. Enter any comments to associate with this configuration.
Select	<ul style="list-style-type: none"> Select the configuration (index 0-9) to use on the instrument. Confirmation will be required for the selected configuration. The instrument must then be restarted (powered off and then back on) in order for the new configuration to take effect.

Section 13 Services Menu

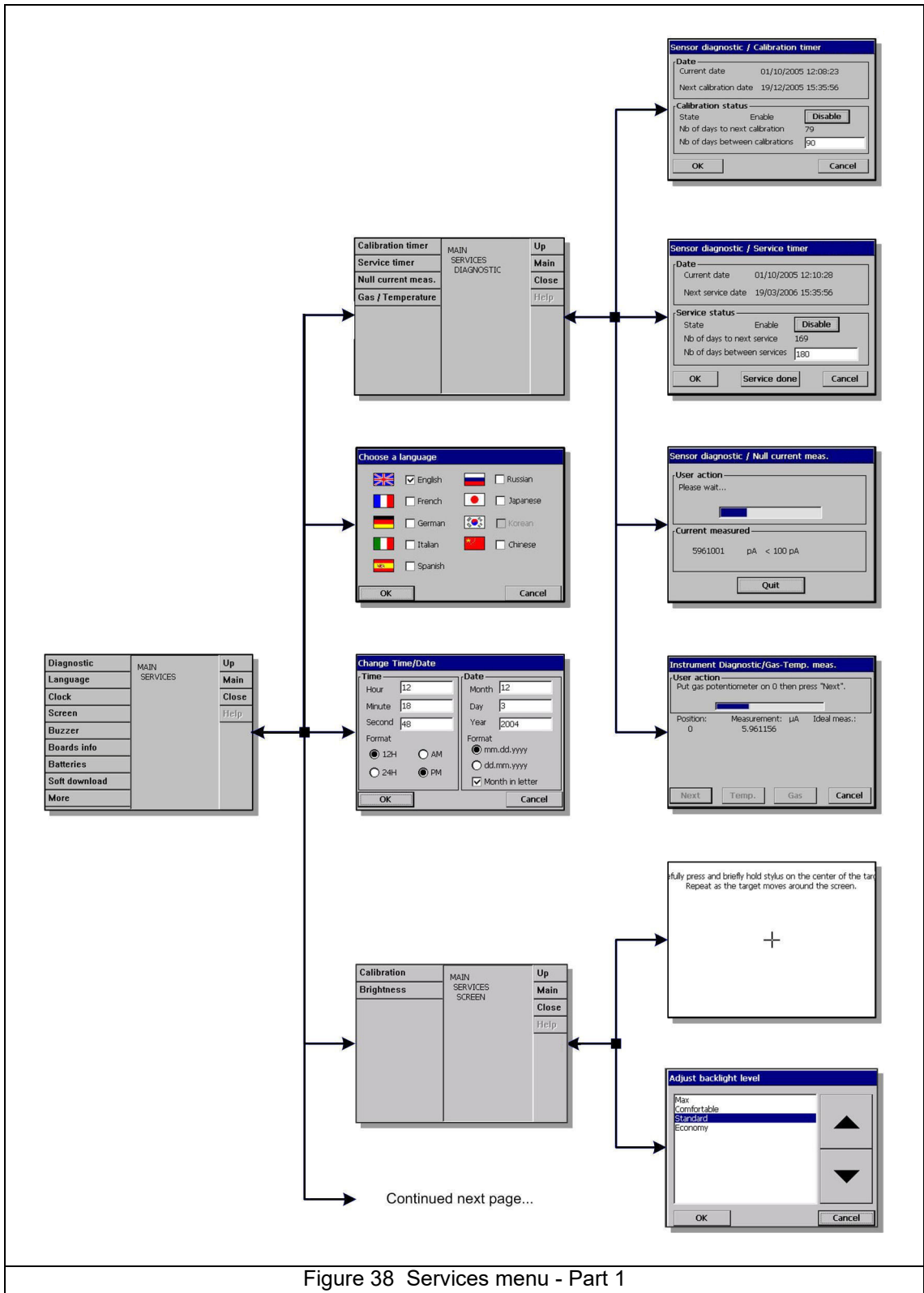

Figure 38 Services menu - Part 1

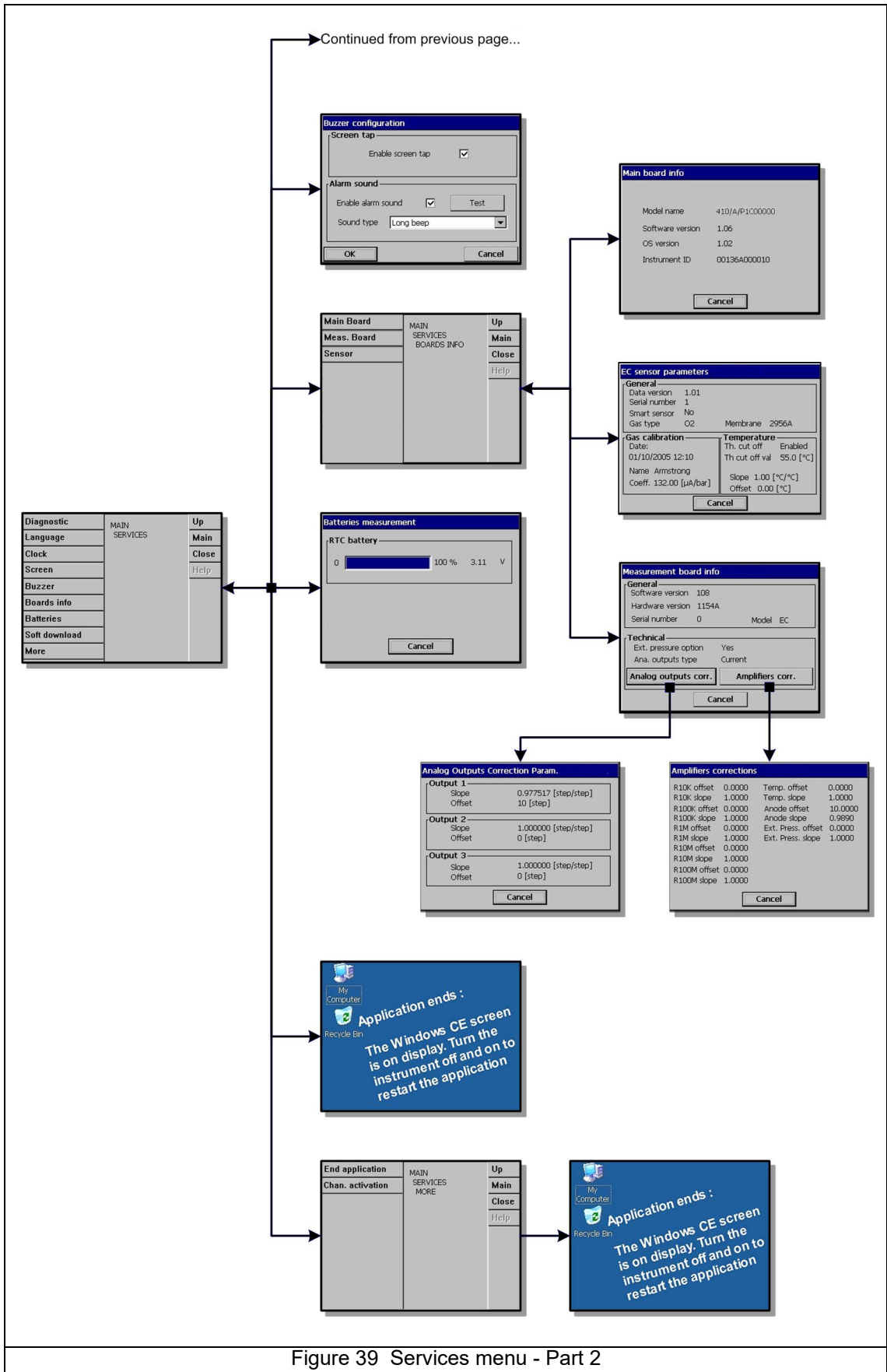

Figure 39 Services menu - Part 2

13.1 Sensor diagnostics

Sensor diagnostics	
Calibration timer	<p>The instrument can automatically remind the user when the next sensor calibration is due.</p> <ul style="list-style-type: none"> Select enable and enter a delay in days. The display shows the current instrument date and time, next calibration due date and time, and the remaining days. <p>The next calibration date is updated when the sensor is calibrated. The event "Cal. required" is generated when the delay has elapsed.</p>
Service timer	<p>The instrument can automatically remind the user when the next sensor service is due.</p> <ul style="list-style-type: none"> Select enable and enter a delay in days. This should be validated by a level 3 user. <p>The display shows the current instrument date and time, the next sensor service due date and time, and the remaining days.</p> <p>The next service date is updated when the button Service done is pressed after a service. The event "Service required" is generated when the delay has elapsed.</p> <p>The sensor attached to your instrument will require periodic servicing and maintenance. For more information on this, please refer to the manual delivered with the sensor.</p>
Null current measurement (EC sensor only)	<p>This is a diagnostic tool for Hach Lange technicians. This feature will allow checking the ability of the EC measurement board to measure a null current. This ability is very important to measure traces of gas.</p> <ul style="list-style-type: none"> Press Start to measure the sensor current generated. <ul style="list-style-type: none"> The measurement board opens a contact in order to measure a null current instead of the sensor current. The window displays the current measured, and information as to whether the value is acceptable or not. <p>If the test fails please contact your Hach Lange representative.</p>
Gas/Temperature (EC sensor process)	<p>This feature allows you to check the ability of the EC measurement board to measure a range of currents and temperatures. To use this feature an EC sensor simulator (Part N° 32304) must be used in place of the sensor.</p> <ul style="list-style-type: none"> Select Temp or Gas and press Start <p>The software performs the check in several steps. It asks the user to select different gas values and temperatures on the simulator. For each position, it applies different anode voltages. For each position and voltage applied:</p> <ol style="list-style-type: none"> it waits some time (typically 1 minute for a null current) it displays if the values measured are acceptable (OK) it displays the current and temperature measured <p>If the current or the temperature is not acceptable, a solution can be the calibration of the "gas amplifier" or the "temperature amplifier". To do this, please contact your Hach Lange representative.</p>
Gas/Temperature (TC sensor process)	<p>This feature allows you to check the ability of the TC measurement board to measure a range of currents and temperatures. To use this feature a TC sensor simulator (Part N° 29117) must be used in place of the sensor.</p> <ul style="list-style-type: none"> Depending on the operation(s) to be performed, select V2, V3, Temp or Select All and press Start <p>The software performs each check in several steps and asks the user to select different values on the simulator. For each position, it applies different anode voltages. For each position and voltage applied:</p> <ol style="list-style-type: none"> it waits some time (typically 1 minute for a null current) it displays if the values measured are acceptable (OK) it displays the current and temperature values measured <p>If the current or the temperature is not acceptable, a solution may be the calibration of the "gas amplifier" or the "temperature amplifier", in which case please contact your Hach Lange representative.</p>

Amplifiers (TC sensor only)	This feature will display the measured values for V2 and V3 along with the recommended values. It is advisable to put the sensor in continuous purge mode during this operation by pressing the Continuous purge button. If the measured and recommended values differ by a large margin, please contact your Hach Lange representative for advice.
------------------------------------	--

13.2 Language selection

Language selection
Check the language as required and restart the instrument to apply the change. The instrument will restart in the language selected.

13.3 Clock

Clock
Type in each appropriate box the actual time and date, and select the display format for them.

13.4 Screen

Screen	
Screen calibration	This screen allows you to adjust the click position corresponding to the displayed buttons. Use it if ever the sensitive areas are no longer properly aligned with the buttons on display. Place the stylus right on the cross when asked and proceed. User will be asked to press on the screen to accept the new setting. If not, the new setting is not recorded and no change is made.
Screen brightness	Press the up or down arrow to increase or decrease the screen brightness. Four levels are pre-set: Max , Comfortable , Standard (default setting) and Economy . Press OK when finished. <i>Note: This can also be called through the brightness icon on the main display.</i>



13.5 Buzzer

Buzzer
Adjust the sounds available on the instrument. When "screen tap" is enabled, a click sound is heard each time the screen is touched. The instrument alarm sound can be enabled or disabled to suit the application. The sound type can also be adjusted. Press the Test button to test the adjustment made. Press again to stop.

13.6 Boards info

Boards info	
Main board info	For reference, this display gives information on the instrument model, software version and instrument ID.
Measurement board info	For reference, this display gives information on the sensor measurement board hardware and software. The Model field indicates if the sensor is an EC or TC sensor. Pressing the Analog outputs corr. button displays the correction factor that is applied to the analog outputs. Pressing the Amplifiers corr. button displays the value of the actual correction factor on the amplifiers.
Sensor parameters	For reference this display gives information on the sensor model and type, last calibration, settings and behavior.

13.7 Batteries

Batteries
On all instruments this display gives the real time clock battery charge level and voltage. <i>Note: A warning message (and icon) is displayed if the battery level becomes too low and needs to be replaced.</i>

13.8 Software download

Software download
For Hach Lange technician use only. Used when reloading the software for new versions. This ends the application. User must stop and restart the instrument to restart the program.

13.9 End application

End application
This ends the application. User must stop and restart the instrument to restart the program.

Section 14 Maintenance and Troubleshooting

14.1 Instrument maintenance

 CAUTION
<p>Personal Injury Hazard. Any instrument maintenance should be carried out by a qualified Hach Lange Service Technician. Please contact your local representative should you feel any maintenance or instrument adjustments are required</p>

14.2 Troubleshooting

The possible events, along with the text message displayed on the instrument numeric view screen, the reason for the event and its criticality are listed in [Table 4 on page 92](#). An event is something which affects the measurement. In the numeric view, the current events are indicated with the gas concentration at the same place.

Whenever an abnormal event is met, a sign is displayed on the upper left of the screen. Pressing on the sign calls a window giving further details about the actual situation.

There are three levels of abnormal conditions:

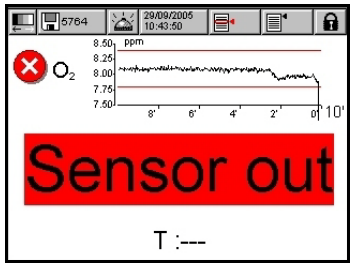
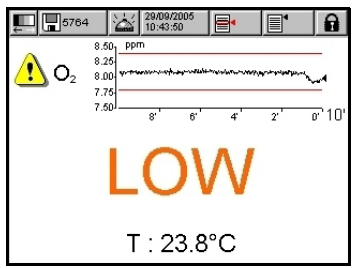
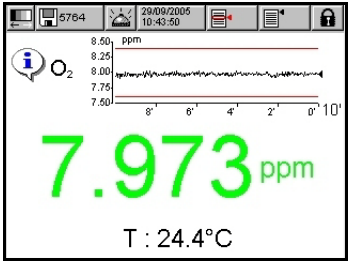

	<ul style="list-style-type: none"> • Alarm - There is a severe problem causing the channel to be out of action, and the system alarm relay to be enabled
	<ul style="list-style-type: none"> • Warning - Events less critical than a system alarm (e.g. measurement alarm)
	<ul style="list-style-type: none"> • Information - For information only; no action is required

Note: Use the Diagnostic view for troubleshooting. Refer to [Sensor diagnostics on page 87](#).

	<p>In addition to the above, if the RTC battery is running low and needs to be changed, the icon illustrated left is displayed in the bottom right corner of the numerical view screen.</p> <p>If using a portable instrument, this icon blinks alternatively with the standard battery icon.</p>
---	---

Note: If the RTC battery is running low, the date and time of the instrument are reset. Also, on startup the instrument will automatically reboot after the initial startup is complete.

14.3 List of events and alarms

Event type	Name	Description	Bit mask value (32 bits long)
 Information	Measure	Normal measurement mode.	0x00000000
	Filter enabled	The gas measurements are filtered.	0x00000001
	Sample measurement	The sample measurement is started.	0x00000002
	Meas. not ready	The measurement is not ready (e.g. at startup)	0x80000000
	Autotest in progress	The autotest is running.	0x00100000
	Autotest failed	The autotest has failed.	0x00200000
	Alarm snooze	The alarm snooze is ON.	0x00000004
 Warning	Calibration	Channel in calibration.	0x00000008
	Alarm low low	The gas concentration below the Alarm LowLow limit.	0x00000010
	Alarm low	The gas concentration is below the Alarm Low limit.	0x00000020
	Alarm high	The gas concentration is above the Alarm High limit.	0x00000040
	Alarm high high	The gas concentration is above Alarm HighHigh limit.	0x00000080
	Calibration required	The calibration of the sensor is required.	0x00000100
	Service required	The sensor requires a service.	0x00000200
	Hold	The measurement is frozen.	0x00400000
	Continuous purge on	Continuous purge is on	0x10000000
 Alarm	Channel disabled	The channel has been disabled.	0x00000400
	Channel out	The measurement board has been disconnected (or does not answer).	0x00000800
	Sensor out	The sensor has been disconnected.	0x00001000
	Thermal cut off	The temperature is above the thermal cut off.	0x00004000
	PROFIBUS-DP	The PROFIBUS-DP module has not received measurements from the instrument for 30 seconds.	0x00080000
	Ramp limit violated	V3 voltage outside range -3V to +8V	0x04000000

14.4 Storage, handling and transportation

Protect the instrument against the elements: rain, splashing, direct sunlight, etc.

A properly packaged instrument can be stored and transported at a temperature -20°C to +70°C and relative humidity up to 80%. Best practice for packing the instrument for transportation is to reuse the original packaging in which the instrument was first delivered. The instrument should be stored in suitable premises, free of dust, condensation and chemical evaporation.

In cold weather, avoid sudden temperature change (like when entering a warm room) and give the instrument enough time to adapt to the ambient temperature in order to avoid condensation inside.

To clean the instrument, wipe the housing clean with a cotton cloth or tissue. Always clean the instrument before storage. Pay attention not to scratch the surface of the display to retain good clarity over time.

NOTICE

Never use liquids such as oil, benzene, or detergents for cleaning the instrument. A mild glass cleaner can be used to remove greasy stains.

Section 15 Part Lists

15.1 Accessories

Part N°	Description
29089	Purge gas pressure regulator kit for TC sensors
32501.03	10 wire cable to connect 31xxx sensors to Orbisphere 410/510 wall and panel instrument, length 3m
32517.00	LEMO 10 adapter to connect 32505 type sensor cable to 410 or 510 wall and panel instruments, length 40 cm
32531.03	Ethernet cable for Orbisphere 410/510 wall and panel instruments including connectors (length = 3m)
32531.10	Ethernet cable for Orbisphere 410/510 wall and panel instruments including connectors, total length = 10 meters
32531.20	Ethernet cable for Orbisphere 410/510 wall and panel instruments including connectors, total length = 20 meters
32534.03	PROFIBUS-DP cable for Orbisphere 410 and 510 instruments including SUB-D 9 female connector (length = 3m)
32605	Purge backup unit for TC sensors
32959	Converter RS232/RS-485 for 3662Ex, 410 and 510. Battery powered; batteries not included.
32973	PROFIBUS-DP upgrade kit for Orbisphere 410 and 510 instruments (includes board and software key)
32501.MM	Longer 10 wire cable to connect 31xxx sensors to Orbisphere 410/510 wall and panel instrument, total length = MM, price added per meter of length greater than 3m.
32517.MM	Longer LEMO 10 adapter to connect 32505 type sensor cable to 410 or 510 wall and panel instruments, total length = MM meters, price to be added by meter
32534.MM	PROFIBUS-DP cable for Orbisphere 410 and 510 instruments including SUB-D 9 female connector, total length = MM, price added per meter of length greater than 3m.
LQV161.52.20000	Thermal printer USB for 410/51x controller (EU)
LQV161.53.20000	Thermal printer USB for 410/51x controller (USA)
LQV161.66.20000	Thermal printer USB for 410/51x controller (AUS/NZ)
LQV161.80.20000	Thermal printer USB for 410/51x controller (CN)
LQV161.82.20000	Thermal printer USB for 410/51x controller (UK)
LZP273	Thermal printer paper (4 rolls)

15.2 Spare parts

Part N°	Description
32963	Wall mounting kit for 410 and 510 instruments
32964	Panel mounting kit for 410 and 510 panel instruments
32972	Pipe mounting kit for 410 or 510 wall instrument
32965	Locking key for Orbisphere 410/510 wall instruments
32970	Cap to protect USB connector on 410 or 510 instruments
32975	Power supply connector (10-30 VDC) for 410/510 panel and wall instruments
DG33263	IP65 sealing kit for 410 and 510 panel instruments

Section 16 Glossary

16.1 Gas units

Unit	Meaning
% air	percentage, by weight. A concentration of 100% air corresponds to liquid saturated with air at current pressure and temperature. The equivalent concentration of O ₂ is approximately 20% O ₂ in normal conditions.
% O ₂	percentage, by weight. A concentration of 100% O ₂ corresponds to liquid saturated with pure O ₂ at current pressure and temperature.
%Vbar	ratio in percent between the partial pressure of gas measured and the atmospheric pressure
%Vext	ratio in percent between the partial pressure of gas measured and the external pressure. Available when an external pressure sensor is present.
µg/L	micrograms per liter
atm	atmosphere
bar, mbar	bar, millibar
cc/kg	volume of gas per kg of liquid. The volume of gas is calculated considering normal conditions (T = 0°C, p = 1atm)
g/kg	grams per kilogram
g/m ³	grams per cubic meter
mg/L	milligrams per liter
ml/L	milliliters per liter
Pa, hPa, kPa	Pascal, hecto Pascal, kilo Pascal
ppb	parts per billion, by weight
ppm	parts per million, by weight (same as mg/kg)
ppm Vb	parts per million, per volume, barometric pressure referenced. = %Vbar / 10,000
ppm Ve	parts per million, per volume, external pressure referenced. = %Vext / 10,000
psia	pound per square inch, absolute
V / V	volume per volume (ratio)

16.2 Generic terms and definitions

Terms	Meaning
Absolute pressure	This is the total pressure in a system (i.e. relative pressure, plus atmospheric pressure)
Analog output	A voltage or current signal that is a continuous function of the measured parameter.
ASCII	American Standard Code for Information Interchange. A standard character-coding scheme used by most computers to display letters, digits and special characters.
Baud rate	Baud rate means transmission speed (Unit: bits per second, bps), especially for RS-232/422/485 interfaces.
CIP	Cleaning In Progress
Concentration	The relative content of a component in a gaseous or liquid media.
Conductivity	The reciprocal of electrical resistivity.
FIFO (First In First Out)	FIFO is a concept to describe the behavior of a buffer. It means the data which entered first will exit first.
Headspace	The empty volume above a liquid or solid in a closed container.

Glossary

Master / Slave modes	A device operating as a master will poll one or more devices operating as a slave. This means a slave device cannot volunteer information; it must wait to be asked for it.
Parallel communication	Parallel communication represents a connection in a computer system in which the bits of a byte are transmitted over separate channels at the same time.
PLC	Programmable Logic Controller. It communicates with other process control components through data links. It is used in process control for simple switching tasks, PID control, complex data manipulation, arithmetic operations, timing and process and machine control.
PROFIBUS-DP	The PROFIBUS-DP (Decentralized Peripheral) fieldbus is designed especially for communication between automation control systems and distributed I/O at the device level. Each DP device has specific parameters such as device version, baud rate, data format, I/O length, user parameters, etc. These parameters are stored in a file with .GSD extension.
PROFIBUS-DP GSD files	The GSD file is provided by the manufacturer and is required for device configuration. A GSD file is a readable ASCII text file that contains both general and device-specific specifications for communication (Communication Feature List) and network configuration.
Relative pressure	Relative pressure is the over pressure in a system (i.e. absolute pressure less atmospheric pressure). This is the customary gauge reading.
Resistivity	The opposition offered by a body or substance to the passage through it of a steady electric current.
RS-232	RS-232 is a serial communication standard providing asynchronous communication capabilities with hardware flow control, software flow control, and parity check. Maximum transmission distance is up to 15 meters at a max. 20,000 bps. A converter is required to interface RS-232 with RS-422 or RS-485.
RS-422	RS-422 is intended for point-to-point communications. It provides much longer transmission distance but less signal line compares to RS-232. RS-422 adopts differential transmission technology and thus provides high-speed transmission up to 10mbps and maximum transmission distance up to 1.2km/110kbps.
RS-485	RS-485 is an enhanced version of RS-422 and is used for multipoint communications, meaning that many devices may be connected to a single signal cable. It is compatible to RS-422 interface and provides 2 wire bus topology.
Serial communication	Serial communication represents a connection in a computer system in which the bits of a byte are transmitted sequentially over a single wire.
Single twisted pair	In this version, all devices are connected to a single Twisted Pair. Thus, all of them must have drivers with tri-state outputs (including the Master). Communication goes over the single line in both directions. It is important to prevent more devices from transmitting at once (software problem).
USB	Universal Serial Bus. An external peripheral interface standard for communication between a computer and external peripherals over a cable using bi-serial transmission. The USB host uses a type A connector.

HACH COMPANY World Headquarters

P.O. Box 389, Loveland, CO 80539-0389 U.S.A.
Tel. (970) 669-3050
(800) 227-4224 (U.S.A. only)
Fax (970) 669-2932
orders@hach.com
www.hach.com

HACH LANGE GMBH

Willstätterstraße 11
D-40549 Düsseldorf, Germany
Tel. +49 (0) 2 11 52 88-320
Fax +49 (0) 2 11 52 88-210
info-de@hach.com
www.de.hach.com

HACH LANGE Sàrl

6, route de Compois
1222 Vérenaz
SWITZERLAND
Tel. +41 22 594 6400
Fax +41 22 594 6499

