



Pompe à vide V-300

La source de vide économique et silencieuse

La pompe à vide à membrane en Téflon résistant aux substances chimiques impressionne par son fonctionnement très silencieux et économique. Avec un débit de 1,8 m³/h et un vide final de 5 mbar, elle convient idéalement pour une utilisation combinée avec le Rotavapor® R-300.

Pratique

Fonctionnement silencieux et détection du niveau du ballon récepteur

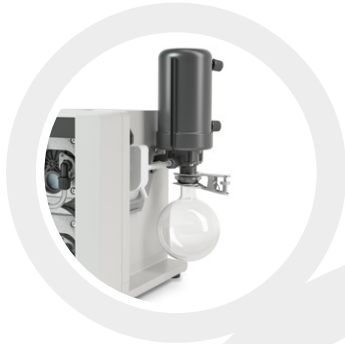

Fiable

Matériaux d'excellente qualité et détection aisée des condensats et particules



Modulable

Intégration homogène plug-and-play sur un Rotavapor® R-300



Pompe à vide V-300

Caractéristiques essentielles et avantages





Intégration homogène

Intégration homogène de la V-300 au sein d'un Rotavapor® R-300 où le vide est régulé de manière centralisée par l'Interface I-300 / I-300 Pro.



Vitesse contrôlée

Le vide recommandé est établi très précisément grâce au fonctionnement à vitesse contrôlée. Grâce à l'absence de variations soudaines de la pression, les risques de «bumping» sont minimisés.

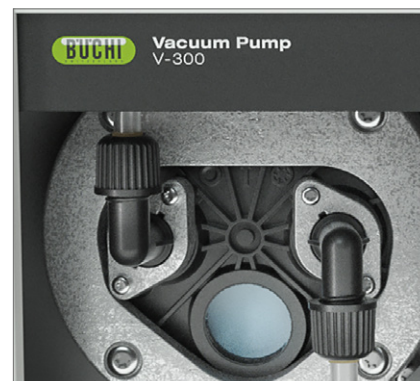

Membranes visibles

Solvants condensés ou particules aisément visibles grâce à un panneau frontal transparent.



Fonctionnement silencieux

Grâce à la vitesse contrôlée, la pompe fonctionne de manière régulière afin de maintenir le vide conseillé. Il en résulte une très faible émission de bruit (32 dB).



Post-réfrigérant secondaire

Le post-réfrigérant secondaire optionnel capture les vapeurs qui seraient autrement libérées dans l'atmosphère du laboratoire.



Capteur de niveau

Combiné à l'Interface I-300 / I-300 Pro, un capteur optionnel avertit, le cas échéant, l'opérateur de la nécessité de vider le ballon de réception.

Performances

Avec un débit de 1,8 m³/h et un vide final de 5 mbar, la Vacuum Pump V-300 peut idéalement être combinée à un évaporateur rotatif.

Vide final : 5 mbar ± 2 mbar

Puissance d'aspiration : 1,8 m³/h

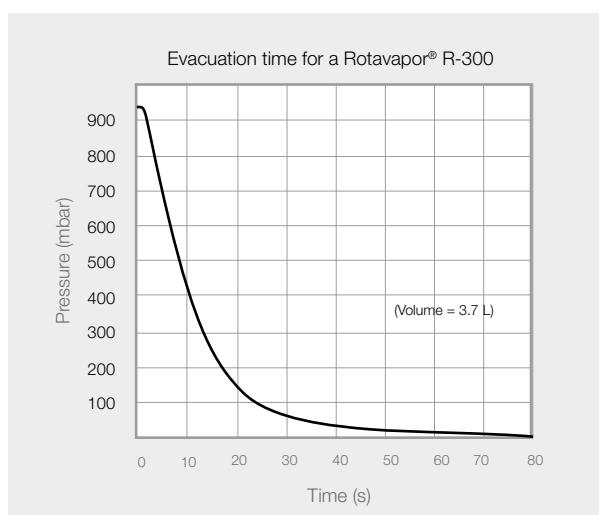

V-300: Aperçu des principaux avantages



Pratique

- Fonctionnement silencieux grâce à la régulation de vitesse
- Traitement sans surveillance en combinaison avec l'Interface I-300 / I-300 Pro associée à un capteur de niveau optionnel pour réfrigérant secondaire qui avertit d'un éventuel débordement du ballon de réception



Fiable

- Résistance chimique élevée grâce à l'utilisation de matériaux de très grande qualité
- Durée de vie prolongée grâce à un fonctionnement à vitesse contrôlée avec l'Interface I-300 / I-300 Pro en option
- Détection visuelle aisée des condensats et particules grâce à un panneau frontal transparent



Modulable

- Intégration transparente plug-and-play dans :
 - un système de vide à vitesse contrôlée avec l'Interface I-300 / I-300 Pro
 - un système BUCHI Rotavapor® R-300 entièrement automatisé incluant tous les paramètres du processus

Complétez votre gamme de produits



Interface I-300 / I-300 Pro

Écran tactile centralisé pour le contrôle, l'enregistrement et la représentation graphique



Rotavapor® R-300

Évaporateur rotatif confortable et efficace



Refroidisseur circulaire F-305 / F-308 / F-314

La méthode de refroidissement efficace et économe en eau



Multivapor™ P-6 / P-12

Évaporation efficace pour plusieurs échantillons





Vacuum Pump V-300 / V-600

Technical data sheet

The Vacuum Pump V-300 and the Vacuum Pump V-600 are chemically resistant PTFE diaphragm pumps. The speed-controlled operation in conjunction with the Interface I-300 / I-300 Pro results in economical operation and very low noise emission. Thanks to the transparent front panel, contaminants are easily visible. It is optimally suited to work with the I-300 / I-300 Pro and R-300.

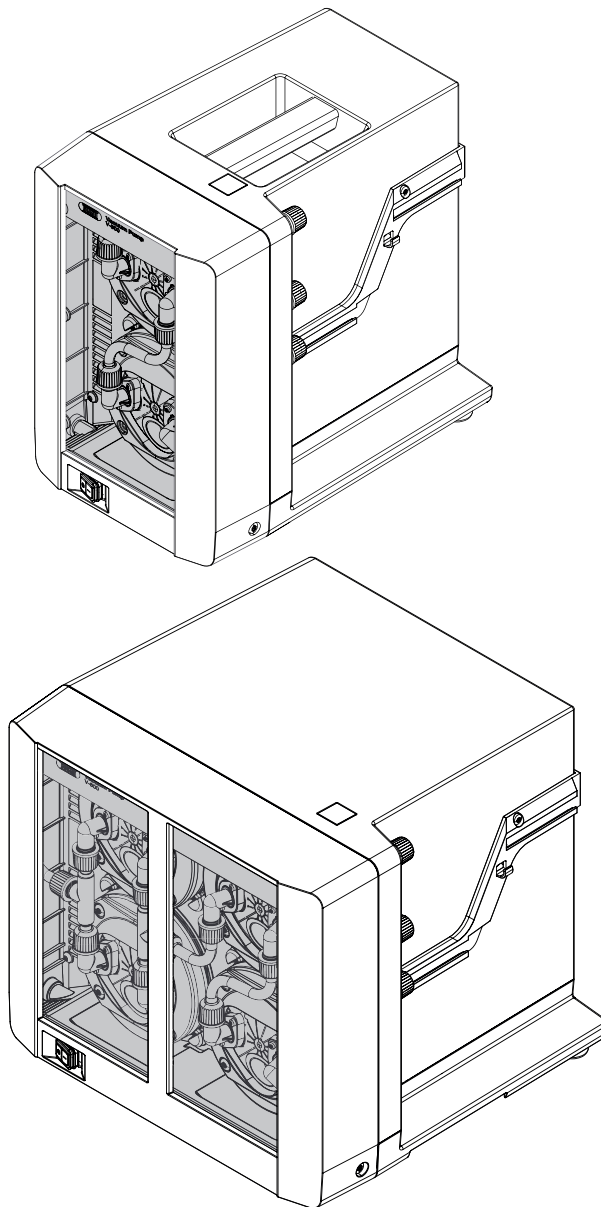

Vacuum Pump V-300 / V-600

Recommended solution with the Vacuum Pump V-300 in combination with the Rotavapor® R-300, the Interface I-300 / I-300 Pro and the Recirculating Chiller F-308 can be found in the System brochure.

All accessories and connections are included for out of the box usage.

Available instruments

Recommended vacuum system

R-300 without Interface I-300 / I-300 Pro, without VacuBox, without Woulff bottle

V-300 with I-300 / I-300 Pro, VacuBox and Woulff bottle

R-300 with I-300 / I-300 Pro and VacuBox and Woulff bottle

V-300

Order Code

Choose the configuration according to your needs:

1 1 V **0 0** **0**

Vacuum Pump

- 3 V-300 (5 mbar, 1.8 m³/h)
- 6 V-600 (1.5 mbar, 3.1 m³/h)

Interface

- 0 Without
- 1 Without, with Woulff bottle
- 2 Interface I-300, with Woulff bottle (incl. VacuBox)
- 3 Interface I-300 Pro, with Woulff bottle (incl. VacuBox)
- 8 Without, for R-220 Pro*

Condensation assembly

- 0 Without
- 1 Secondary condenser with insulation
- 2 Secondary cold trap

* For V-600 only

Scope of delivery

All configurations are supplied ready to use.

Component	V-300	V-600
Vacuum Pump V-300	1	
Vacuum Pump V-600		1
Vacuum tubing	1	1
Power cable	1	1
Silencer	1	1
Tubing connections (set)	1	1
Communication cable (Mini-DIN)	1	1
Membrane tool (to fasten and remove membrane)	1	1
Interface I-300 / I-300 Pro (incl. holder)	*	*
Woulff bottle	*	*
VacuBox (incl. communication cable)	*	*
Accessories needed for R-220 Pro	-	*
Condensation assembly	*	*

* Optional, according to order code

Technical data

Vacuum Pump

Specification	V-300	V-600
Dimensions (W x D x H)	200 x 321 x 291 mm	330 x 321 x 291 mm
Dimensions (W x D x H)	585 x 385 x 370 mm	585 x 385 x 370 mm
Shipping box without secondary assembly		
Dimensions (W x D x H)	585 x 385 x 540 mm	585 x 385 x 540 mm
Shipping box with secondary assembly		
Weight (without accessories)	7.6 kg	13.9 kg
Suction capacity	1.8 m ³ /h	3.1 m ³ /h
Number of steps (heads)	2 (2)	3 (4)
Final vacuum (absolute)	5 mbar (± 2 mbar)	1.5 mbar (± 1 mbar)
Vacuum connection	GL14	GL14
Power consumption	180 W	360 W
Power consumption, energy saving mode 1 (80%)	95 W	190 W
Power consumption, energy saving mode 2 (50%)	60 W	120 W
Power supply voltage	100 – 240 VAC	100 – 240 VAC
Frequency	50/60 Hz	50/60 Hz
Maximum speed	1500 rpm	1500 rpm
Sound level (depending on operating mode)	32 – 57 dBA	40 – 64 dBA
Sound level with 10 % load (normal)	32 dBA	40 dBA
Sound level with 100 % load	57 dBA	64 dBA
Overvoltage category	II	II
IP Code	IP20	IP21
Pollution degree	2	2
Inlet temperature of media in ATEX 3G T3 IIC X operation mode	< 40 °C	< 40 °C
Ignition temperature of media in ATEX 3G T3 IIC X operation mode	> 200 °C	> 200 °C
Approvals	CE / CSA / CUS	CE / CSA / CUS

Special features

Vacuum Pump

V-300 / V-600

Firmware update	With the BUCHI Monitor App and BUCHI Bluetooth Dongle, firmware updates can be easily done by the user at no costs.
Inspection window	A large glass window at front side Allows to observe the two pump heads and membranes for eventual dirt particles
Power saving mode (without I-300 / I-300 Pro)	Pump automatically switches to power saving mode after a given operation time Reduces power consumption while maintaining same terminal vacuum
Level sensor (in combination with Interface I-300 / I-300 Pro only)	Warns of overflow into receiving flask of condenser/secondary condenser When solvents reaches a certain level, a warning pops up at interface and is sent to smartphone/tablet
Control two Rotavapor® systems in parallel	Operate two systems (in combination with 2 Interface I-300 / I-300 Pro only) Allows an upgrade to control two vacuum sources with two Rotavapor® systems simultaneously

Compatibility and communication requirements with a V-300 / V-600

Interface / Vacuum Controller	Compatibility / Mode	Communication requirements
I-300 / I-300 Pro	compatible speed controlled	VacuBox 2x Communication cable. BUCHI COM 6p: 11058705 (0.3 m), 11058707 (1.8 m), 11058708 (5 m) or 11064090 (15 m)
I-100	compatible on/off	Communication cable. Mini-DIN 8p: 11060882 (0.6 m) or 038010 (1.5 m) Power adapter (11060669)
V-850 / V-855	compatible speed controlled	Communication cable. Mini-DIN 6p to RJ45 11060649 (1.5 m) or 11064104 (3 m)
V-800 / V-805	compatible on/off	Communication cable. Mini-DIN 8p 11060882 (0.6 m) or 038010 (1.5 m) Power cable 2p (1.8 m)

Explanation of terms

speed controlled	Vacuum pump is turned on/off as well as speed controlled via interface/vacuum controller.
on/off	Vacuum pump is automatically turned on/off via interface/vacuum controller

A VacuBox is included when ordering Rotavapor® R-300 with an Interface I-300 or Interface I-300 Pro compatibility pack.

Feature comparison (V-300 / V-600 and Interface)

Vacuum Pump features	I-300 Pro / I-300	I-100	V-850 / V-855	V-800 / V-805	Without interface
Power saving mode					•*
Speed control	•		•		
Level sensor for receiving flask	•				
Generic features	I-300 Pro / I-300	I-100	V-850 / V-855	V-800 / V-805	Without interface
Live data charting	only I-300 Pro				
Leak test	•				
Dynamic distillation (only when connected with Rotavapor® R-300)	•				
Solvent Library	•		•		
Data recording	only I-300 Pro		Optional via PC SW		
Guided operation (methods)	only I-300 Pro		gradients	gradients	
AutoDest	•		•	•	
Timer	•	•	•	•	
CloudDest (Only when connected to a Rotavapor® R-300)	•				

* System without the interface runs autonomously.

Description of function

The diaphragm pump is a positive displacement pump that uses a combination of the reciprocating action of a PTFE diaphragm and non-return check valves. The eccentric module lets the diaphragm move strictly axial which leads to an increased service life.

Energy saving mode

This power saving mode is automatically activated in unregulated operation (as a standalone, without an Interface I-300 or I-300 Pro), hence the pump does not work at its full capacity. The energy saving mode is activated after 1 hour of operation, where the pump works at 80 %. After 2 hours, it reduces to 50 %. In the energy saving mode the pump consumes less electrical power and works under reduced stress, accordingly, the overall maintenance costs will be reduced over the lifetime of the pump.

Performance characteristics

The V-300 and V-600 have a good suction capacity also at a low pressure. The graphs in the top row show suction capacity against pressure. The graphs in the bottom row show the evacuation time of a laboratory evaporator (left side) and an industrial evaporator (right side).

V-300

V-600

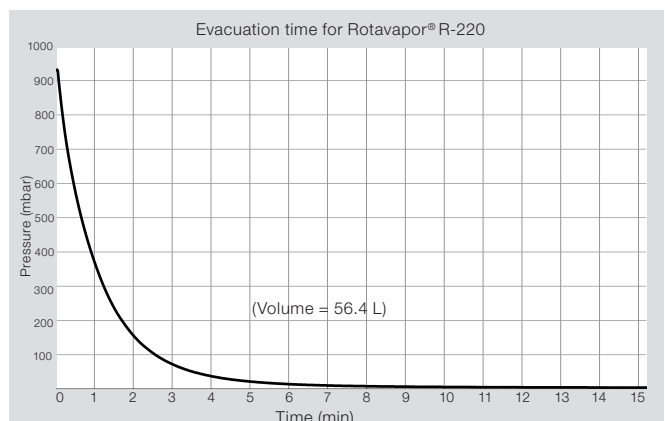
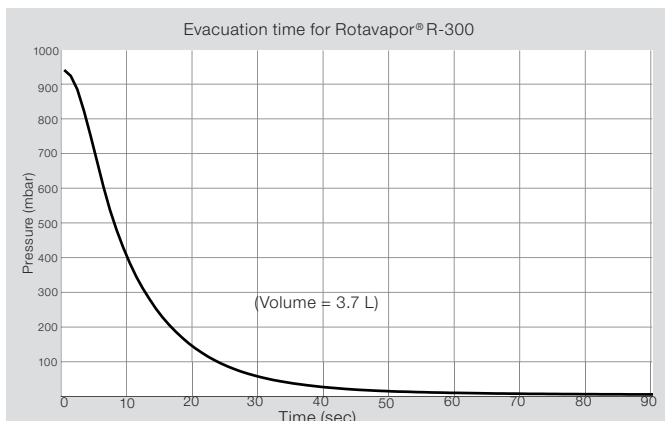
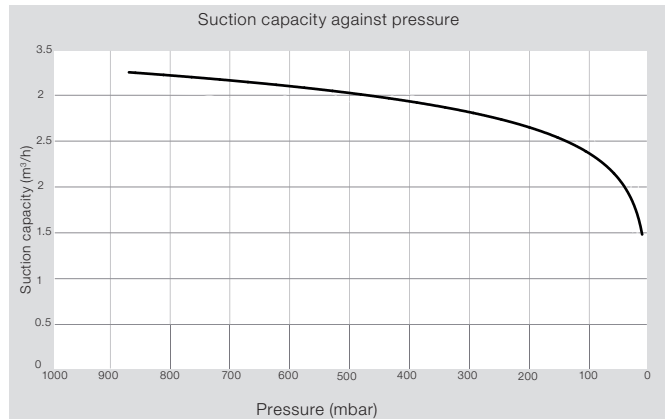
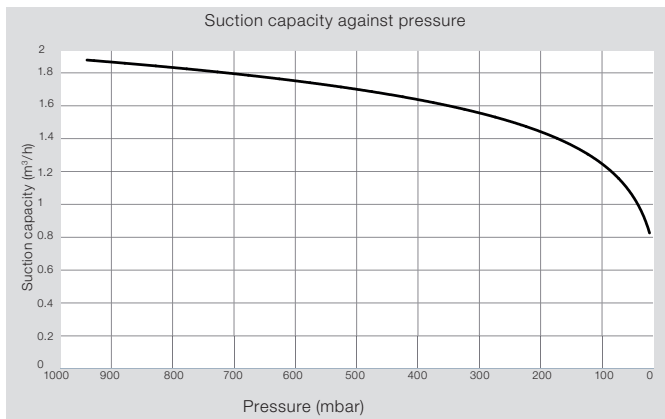

Upgrades

Upgrade the Vacuum Pump V-300 / V-600 to a speed controlled vacuum source







The Vacuum Pump V-300 / V-600 can easily be upgraded to a controlled vacuum source by adding the Interface I-300 / I-300 Pro (incl. VacuBox and Woufff bottle).

Upgrade the Vacuum Pump V-300 / V-600 to operate with 2 Rotavapor® systems

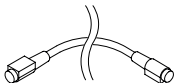
The Vacuum Pump V-300 / V-600 can easily be upgraded to work with two vacuum loads via Interface I-300 / I-300 Pro simultaneously (on/off communication, not speed controlled).

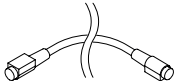
Accessories

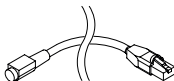
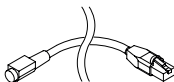
Communication cables

	Order no.	Image
Communication cable. BUCHI COM, 0.3 m, 6p Enables connection between Rotavapor® R-300 / R-220 Pro, Interface I-300 / I-300 Pro, Vacuum Pump V-300 / V-600, Recirculating Chiller F-3xx, VacuBox and LegacyBox.	11058705	
Communication cable. BUCHI COM, 1.8 m, 6p Enables connection between Rotavapor® R-300 / R-220 Pro, Interface I-300 / I-300 Pro, Vacuum Pump V-300 / V-600, Recirculating Chiller F-3xx, VacuBox and LegacyBox.	11058707	
Communication cable. BUCHI COM, 5.0 m, 6p Enables connection between Rotavapor® R-300 / R-220 Pro, Interface I-300 / I-300 Pro, Vacuum Pump V-300 / V-600, Recirculating Chiller F-3xx, VacuBox and LegacyBox.	11058708	
Communication cable. BUCHI COM, 15 m, 6p Enables connection between Rotavapor® R-300 / R-220 Pro, Interface I-300 / I-300 Pro, Vacuum Pump V-300 / V-600, Recirculating Chiller F-3xx, VacuBox and LegacyBox.	11064090	
Communication cable. Mini-DIN 6p to RJ45, 1.5 m Connection between Vacuum Controller V-850 / V-855 and Vacuum Pump V-300 / V-600 or between Vacuum Controller V-850 / V-855, Interface I-100 and Recirculating Chiller F-305 / F-308 / F-314.	11060649	
Communication cable. Mini-DIN 6p to RJ45, 3 m Connection between Vacuum Controller V-850 / V-855 and Vacuum Pump V-300 / V-600 or between Vacuum Controller V-850 / V-855, Interface I-100 and Recirculating Chiller F-305 / F-308 / F-314.	11064104	
Communication cable. Mini-DIN, Y-piece, 2.0 m Meant to be used with 1 Vacuum Pump V-300 and 2 Rotavapor® systems with the Interface I-300/I-300 Pro. Connection between VacuBox and Vacuum Pump V-300.	11062255	

Tubing

	Order no.
Tubing. FEP, Ø6/8 mm, transparent, per m Use: Vacuum, cooling media.	027900
Tubing. Natural rubber, Ø6/16 mm, red, per m Use: Vacuum.	017622
Tubing. Nylflex, PVC-P, Ø8/14 mm, transparent, per m	004113
Tubing. PTFE, Ø8/10 mm, white, per m Use: Vacuum, feeding (industrial Rotavapor®).	027277
Tubing. Silicone, Ø6/9 mm, transparent, per m Use: Cooling media.	004133
Tubing. Synthetic rubber, Ø6/13 mm, black, per m Use: Vacuum.	11063244

Other accessories

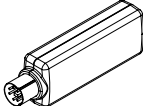
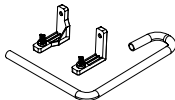
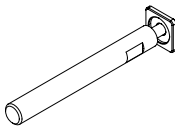
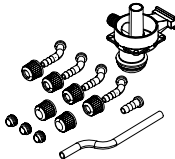
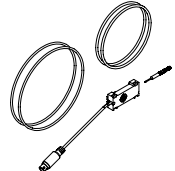
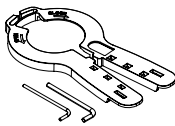
	Order no.	Image
BUCHI Bluetooth® Dongle, connects instrument to smartphone via Bluetooth® Needed for firmware updates, eSupport or quoting wear parts.	11067770	
Fastening set. For VacuBox, incl. holder 2 pcs, tube Used to fasten VacuBox on the Vacuum Pump V-300 or V-600.	11062957	
Holder, set. To fix V-8xx, I-100 or Manometer on V-300 / V-600 Used to mount Vacuum Controller V-8xx, Manometer or Interface I-100 on the Vacuum Pump V-300 / V-600. Content: rod and intermediate plate.	11065224	
Holder set. For V-7xx secondary condenser on V-300 / V-600 Used to mount V-7xx secondary condenser on the Vacuum Pump V-300 or V-600.	11065095	
Level sensor. Incl. O-ring, cable, rubber band Prevents an overflow in the receiving flask of condenser/secondary condenser. Placed on receiving flask. Meant to be used with the Interface I-300 / I-300 Pro.	11060954	
Membrane clamp. Incl. torx wrench TX25, TX10 To fasten and remove membranes.	11062343	

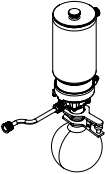
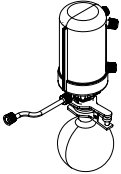
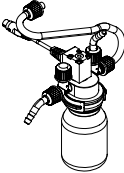
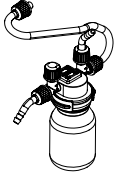
	Order no.	Image
<p>Secondary condenser C, set. Cold trap P+G-LT, incl. V-300 holder</p> <p>Condenses remaining vapors after the vacuum pump outlet. Application temperature: -70 to 40 °C. Used with ice/dry ice. Content: Cold trap P+G-LT, 500 mL receiving flask, ball joint clamp, V-300 holder. Compatible with V-300 and V-600 vacuum pumps.</p>	11060050	
<p>Secondary condenser V, set. Glass condenser, incl. insulator and V-300 holder</p> <p>Condenses remaining vapors after the vacuum pump outlet. Used along with a recirculating chiller or tap water. Content: glass condenser, receiving flask 500 mL, insulator for condenser, ball joint clamp, V-300 holder. Compatible with V-300 and V-600 vacuum pumps.</p>	11059900	
<p>Valve unit. Incl. Woulff bottle, 125 mL, P+G, holder</p> <p>Magnetic valve, meant to be used with the Interface I-300/I-300 Pro. For operation with non-BUCHI vacuum pumps or house vacuum.</p>	11061887	
<p>Woulff bottle. 125 mL, P+G, incl. holder</p> <p>For trapping particles and droplets and for pressure equalization.</p>	11059905	

Receiving flask

	Order no.
Glass, SJ35/20, 250 mL, P+G	11060907
Glass, SJ35/20, 250 mL	000423

Wearing parts





Seals

	Order no.
Gasket. Flat gasket, silicone, PTFE	047165
Seal. For cap nut GL14 to FEP, EPDM	038225
Seals, set. 10 pcs, for hose barbs GL14, EPDM, black	040029
Seals, set. 10 pcs, for hose barbs GL14, FPM, green	040040
Seals, set. 10 pcs, for hose barbs GL14, silicone, red	040023

Hose barbs

	Order no.	Image
Hose barbs. set. 3 pcs, bent, GL14, silicone seal Content: Hose barbs, seals.	041987	
Hose barbs, set. 4 pcs, bent GL14, silicone seal Content: Hose barbs, cap nuts, seals	037287	
Hose barbs. set. 4 pcs, bent, GL14, EPDM seal Content: Hose barbs, cap nuts, seals.	043129	
Hose barbs. set. 4 pcs, bent, GL14, FEP seal Content: Hose barbs, cap nuts, seals.	040295	
Hose barbs. set. 4 pcs, straight, GL14, EPDM seal Content: Hose barbs, cap nuts, seals.	043128	
Hose barbs. set. 4 pcs, straight, GL14, FPM seal Content: Hose barbs, cap nuts, seals.	040296	
Hose barbs, set. 4 pcs, straight, GL14, silicone seal Content: Hose barbs, cap nuts, seals	037642	
Hose barbs. set. 6 pcs, bent (4), straight (2), GL14, silicone seal Content: Hose barbs, cap nuts, seals.	038000	

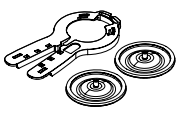
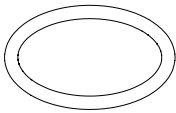
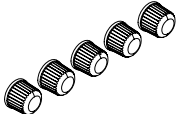
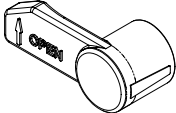
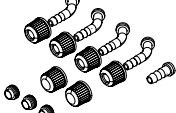
Miscellaneous wearing parts

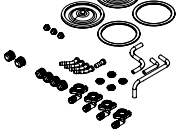
	Order no.	Image
Cap nuts, set. 10 pcs, screw cap with hole GL14, seal EPDM Content: Cap nuts, seals	041999	
Cap nuts. set. 10 pcs, screw cap with hole, GL14	041956	
Membrane, set. 2x, for V-300 / V-600, V-100, V-7xx Content: 2 membranes with support rings and 1 membrane clamp.	11065776	
O-ring. For secondary condenser, FKM/FEP, Ø28.2/2.6 mm	11057661	
Screw caps. set. 5 pcs, GL14	040624	
Set gas ballast. Incl. gas ballast, clip, lever	11062527	
Screwing set, Hose barbs and seals GL14 Content: Hose barbs bent 4 pcs, hose barbs straight 1 pc, cap nuts 4 pcs, screw caps 2 pcs, seals EPDM 3 pcs.	11061921	
Set wear part for V-600, incl. membranes, hoses and hose barbs Content: Membrane 4 pcs, support ring 4 pcs, check valves 4 pcs, FEP tubes, T-connector and hose barbs. Only for Vacuum Pump V-600.	11065180	
Set wear part. Membranes, hose barbs Content: Membrane 2 pcs, support ring 2 pcs, valve 4 pcs, tube intake, tube connection, tube exhaust, elbow fitting 4 pcs, set hose barbs (11061921). For use with Vacuum Pump V-300.	11062525	

Additional glassware

Additional glassware like evaporating flasks, drying flasks, receiving flasks, beaker flasks, Reitmeyer adapters (bump traps) and distillation spiders can be found in the Laboratory Evaporation Glassware brochure.